



# USER'S MANUAL



---

## THREE-PHASE STRING INVERTERS

3PH 3.3KTL-12KTL-V3

---



**ZUCCHETTI**  
Centro Sistemi



GREEN  
INNOVATION

# Grid-connected inverter

## 3PH 3.3K - 12K TL-V3

# User Manual



# Table of Contents

1.	Preliminary safety instructions .....	8
1.1.	Safety instructions .....	8
1.2.	Symbols and icons.....	11
2.	Product features.....	13
2.1.	Product presentation.....	13
2.2.	Description of functions .....	16
2.3.	Module protection.....	17
2.4.	Efficiency curve.....	18
3.	Installation.....	19
3.1.	Installation process .....	20
3.2.	Checks before installation.....	20
3.3.	Installation tools.....	23
3.4.	Installation position .....	25
3.5.	Moving the 3PH 3.3K-12K TL-V3 inverter.....	27
3.6.	Installing the 3PH 3.3K-12K TL-V3 inverter.....	28
4.	Electrical connections.....	29
4.1.	Electrical connections .....	30
4.2.	Connecting PNGD cables (grounding).....	30
4.3.	Connecting the DC input power cables .....	32
4.4.	Connecting the AC output power cables.....	37
4.5.	Connecting the communication cables .....	41
5.	Commissioning the inverter.....	45
5.1.	Safety inspection before commissioning.....	45
5.2.	Starting the inverter .....	46
6.	Operating interface .....	47
6.1.	Operating panel and display .....	47
6.2.	Main interface .....	48
6.3.	Main menu.....	52

6.4.	Updating Inverter Software .....	61
7.	Troubleshooting and maintenance .....	63
7.1.	Troubleshooting.....	63
7.2.	Maintenance .....	71
8.	Uninstalling .....	72
8.1.	Uninstallation steps.....	72
8.2.	Packaging.....	72
8.3.	Storage .....	72
8.4.	Disposal .....	72
9.	Technical specifications .....	73
10.	Monitoring systems.....	74
10.1.	External Wi-Fi adapter.....	74
10.1.1.	Installation .....	74
10.1.2.	Configuration .....	76
10.1.3.	Verification.....	85
10.1.4.	Troubleshooting.....	88
10.2.	Ethernet adapter.....	93
10.2.1.	Installation .....	93
10.2.2.	Verification.....	95
10.2.3.	Troubleshooting.....	97
10.3.	4G adapter .....	98
10.3.1.	Installation .....	98
10.3.2.	Verification.....	101
10.4.	Datalogger .....	104
10.4.1.	Preliminary notes on how to configure the datalogger .....	104
10.4.2.	Electrical connections and configuration.....	105
10.4.3.	ZSM-DATALOG-04 AND ZSM-DATALOG-10 DEVICES .....	108
10.4.4.	WI-FI CONFIGURATION.....	108
10.4.5.	Ethernet configuration.....	108
10.4.6.	Checking that the datalogger has been configured correctly .....	115
10.4.7.	ZSM-RMS001/M200 and ZSM-RMS001/M1000 Devices .....	118



10.4.7.1.	Mechanical description and Datalogger interface .....	118
10.4.7.2.	Connecting the Datalogger to the inverters.....	118
10.4.7.3.	Internet connection via Ethernet cable.....	119
10.4.7.4.	Connecting the power supply and battery pack to the Datalogger .....	119
10.4.7.5.	Connecting the LM2-485 PRO cell irradiance and temperature sensor to the datalogger .....	120
10.4.8.	Configuring the Datalogger .....	121
10.4.8.1.	Configuring the Datalogger on the ZCS Azzurro portal.....	123
10.4.8.2.	Network configuration.....	124
10.4.9.	Local monitoring.....	125
10.4.9.1.	Requirements for installation of local monitoring .....	126
10.4.9.2.	Features of local monitoring .....	126
11.	Warranty terms and conditions.....	127

### **General instructions**

This manual contains important safety instructions that must be followed during installation and maintenance of the equipment.

### **Please keep these instructions!**

This manual must be considered an integral part of the equipment, and must be available at all times to everyone who interacts with the equipment. The manual must always accompany the equipment, even when it is transferred to another user or plant.

### **Copyright statement**

Copyright of this manual belongs to Zucchetti Centro Sistemi S.p.A. No part of this manual (including the software, etc.) may be copied, reproduced or distributed in any form or by any means without the permission of Zucchetti Centro Sistemi S.p.A. All rights reserved. ZCS reserves the right to final interpretation. This manual is subject to change based on feedback from users, installers or customers. Please check our website at <http://www.zcsazzurro.com> for the latest version.

### **Technical support**

ZCS offers a support and technical consultancy service accessible by sending a request directly from the website <https://www.zcsazzurro.com/it/support>.

The following toll-free number is available for the Italian territory: 800 72 74 64.

## Preface

### General information

Please read this manual carefully before installation, use or maintenance.

This manual contains important safety instructions that must be followed during installation and maintenance of the system.

### Scope

This manual describes the assembly, installation, electrical connections, commissioning, maintenance and troubleshooting of the following inverters:

**3PH 3.3K TL-V3 / 3PH 4.4K TL-V3 / 3PH 5.5K TL-V3 / 3PH 6.6K TL-V3 / 3PH 8.8K TL-V3 / 3PH 11K TL-V3 / 3PH 12K TL-V3**



Keep this manual so that it is accessible at all times.



### Recipients

This manual is intended for qualified technical personnel (installers, technicians, electricians, technical support personnel or anyone who is qualified and certified to operate a photovoltaic system), who are responsible for installing and starting the inverter in the photovoltaic system and for operators of the photovoltaic system.

### Symbols used

This manual provides information for safe operation and uses certain symbols to ensure the safety of personnel and materials, and for efficient use of the equipment during normal operation. It is important to understand this information to avoid accidents and damage to property. Please take note of the following symbols used in this manual.

	<p><b>Danger: indicates a hazardous situation which, if not resolved or avoided, could result in serious personal injury or death.</b></p>
<p><b>Danger</b></p>	
	<p><b>Warning: indicates a hazardous situation which, if not resolved or avoided, could result in serious personal injury or death.</b></p>
<p><b>Warning</b></p>	

	<p><b>Caution:</b> indicates a hazardous situation which, if not resolved or avoided, could result in minor or moderate personal injury.</p>
<p><b>Caution</b></p>	
	<p><b>Attention:</b> indicates a potentially hazardous situation which, if not resolved or avoided, could result in damage to the system or other property.</p>
<p><b>Attention</b></p>	
	<p><b>Note:</b> provides important tips on the correct and optimal operation of the product.</p>
<p><b>Note</b></p>	





## 1. Preliminary safety instructions



### Note

If you have problems or questions regarding the reading and understanding of the following information, please contact Zucchetti Centro Sistemi S.p.A. through the appropriate channels.

### General information in this chapter

#### Safety instructions

It mainly highlights the safety instructions to be followed during installation and use of the equipment.

#### Symbols and icons

Introduces the main safety symbols on the inverter.

### 1.1. Safety instructions

Before installing and using the equipment, make sure you read and understand the instructions in this manual and familiarise yourself with the relative safety symbols shown in this chapter.

Depending on national and local requirements, permission must be obtained from your local provider before connecting to the electrical grid, making sure that the connections are carried out by a qualified electrician.

Contact the nearest authorised service centre for any repairs or maintenance. Contact your distributor for information on the nearest authorised service centre. **DO NOT** carry out repairs yourself, as this may result in injury or damage.

Before installing and operating the equipment, the electrical circuit of the strings must be disconnected by opening the string circuit breaker to interrupt the high-voltage DC of the photovoltaic system. Failure to do so could result in serious injury.

#### Qualified personnel

Ensure that the operator has the necessary skills and training to operate the equipment. Personnel responsible for use and maintenance of the equipment must be qualified and capable of performing the activities described, and must also have appropriate knowledge on how to correctly interpret the contents of this manual. For safety reasons, this inverter can only be installed by a qualified electrician with the necessary training and/or skills and knowledge. Zucchetti Centro Sistemi S.p.A. declines all responsibility for damage to property or personal injury caused by incorrect use of the device.

## Installation requirements

Install and start the inverter according to the following instructions. Place the inverter on suitable load-bearing supports with sufficient load capacity (such as walls or photovoltaic racks) and make sure that the inverter is positioned vertically. Choose a suitable location for the installation of the electrical equipment.

Make sure there is sufficient space for heat dispersion and to accommodate future maintenance. Maintain adequate ventilation and ensure that there is enough air circulation for cooling.

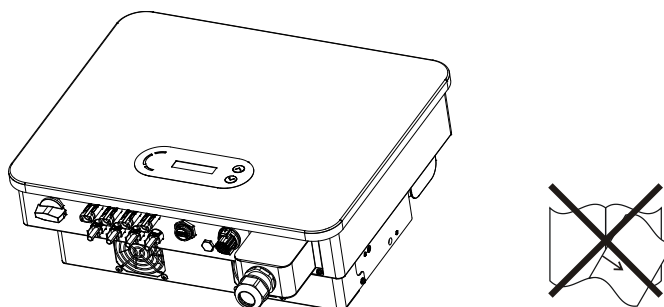



Figure 1 - Do not lose or damage this manual



## Transport requirements

If you have problems with the packaging that could damage the inverter or if you find any visible damage, immediately notify the transport company. If necessary, request assistance from an installer of photovoltaic systems or from Zucchetti Centro Sistemi SpA. Transport of the equipment, especially by road, must be carried out with vehicles suitable to protect the components (in particular, electronic components) against violent knocks, humidity, vibrations, etc.



## Electrical connections

Please pay attention to the electrical regulations on accident prevention when dealing with photovoltaic inverters.



	<p><b>Before connecting the mains power, be sure to disconnect the photovoltaic modules by disconnecting all the DC switches of the generator. When exposed to the sun, the photovoltaic panels produce a voltage that can be dangerous!</b></p>
<p><b>Danger</b></p>	

	<p>All installation operations must be carried out by a professional electrician, who must:</p> <ul style="list-style-type: none"> <li>• be prepared.</li> <li>• Carefully read this manual and understand its contents.</li> </ul>
<b>Warning</b>	
	<p>Before connecting the inverter to the grid, make sure that all the necessary permits have been obtained from the local grid operator and that all the electrical connections are made by a professional electrician.</p>
<b>Attention</b>	
	<p>Do not remove the information label or open the inverter.</p> <p>Otherwise, ZCS will not provide any warranty or maintenance.</p>
<b>Note</b>	

## Operation



	<p>Contact with the electrical grid or the terminal of the equipment may cause electrocution or fire!</p> <ul style="list-style-type: none"> <li>• Do not touch the terminal or the conductor connected to the electrical grid.</li> <li>• Follow all the instructions and safety requirements relating to the mains connection.</li> </ul>
<b>Danger</b>	
	<p>Some internal components reach very high temperatures when the inverter is in operation. Wear protective gloves!</p>
<b>Attention</b>	

## Maintenance and repair

	<ul style="list-style-type: none"> <li>• Before carrying out any repairs, disconnect the inverter from the mains network (AC side) and from the photovoltaic system (DC side).</li> <li>• After switching off the AC and DC switches, wait 5 minutes before carrying out any repairs or maintenance on the inverter!</li> </ul>
<b>Danger</b>	
	<ul style="list-style-type: none"> <li>• The inverter should start working again after any faults have been fixed. For any repairs, contact your local authorised service centre;</li> <li>• Do not disassemble the internal components of the inverter without permission. This will void the warranty. Zucchetti Centro Sistemi S.p.A. shall not be responsible for any damage or loss caused by these actions.</li> </ul>
<b>Attention</b>	

## 1.2. Symbols and icons









### Safety signals

	<p>Pay attention to possible burns due to hot parts.</p> <p>Only touch the screen or press the keys while the inverter is in operation.</p>
<b>Caution</b>	
	<p>The PV strings should be connected to the ground in accordance with the local regulations!</p> <p>To ensure the safety of the system and people, the inverter and photovoltaic strings must be securely connected to the ground.</p>
<b>Attention</b>	
	<p>Ensure the correct DC input voltage; which must be below the maximum allowable DC voltage. Overvoltage can cause permanent damage to the inverter or other faults which are not covered by the warranty!</p>
<b>Warning</b>	

### Symbols on the inverter

Some safety symbols are located on the inverter. Read and understand the contents of the symbols before

installing the inverter.

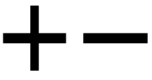
	<p>Residual voltage may be present on the inverter! Before opening the inverter, wait 5 minutes to ensure that the capacitors are completely discharged.</p>
	<p>Beware of high voltage</p>
	<p>Beware of high temperatures</p>
	<p>Complies with the European Standards (CE)</p>
	<p>Ground connection point</p>
	<p>Read this manual before installing the inverter.</p>
	<p>Indication of the allowable temperature range</p>
	<p>Degree of protection of the equipment according to the IEC 70-1 standard (EN 60529 June 1997).</p>
	<p>Positive and negative polarities of the input voltage (DC).</p>

## 2. Product features

### General information in this chapter

#### Product overview

The field of use and overall dimensions of the 3PH 3.3K-12K TL-V3 inverters are indicated in this section.

#### Description of functions

It describes how the 3PH 3.3K-12K TL-V3 inverters and their internal operating modules work.

#### Efficiency curve

It describes the efficiency curves of the inverter.

### 2.1. Product presentation

#### Field of use

The 3PH 3.3K-12K TL-V3 inverters are grid-connected photovoltaic inverters equipped with a dual-channel-MPPT, capable of converting the direct current generated by the photovoltaic strings into three-phase sine wave alternating current and feeding the energy to the public electricity grid. An AC circuit breaker (see related chapter) must be used as a disconnecting device and must always be easily accessible.

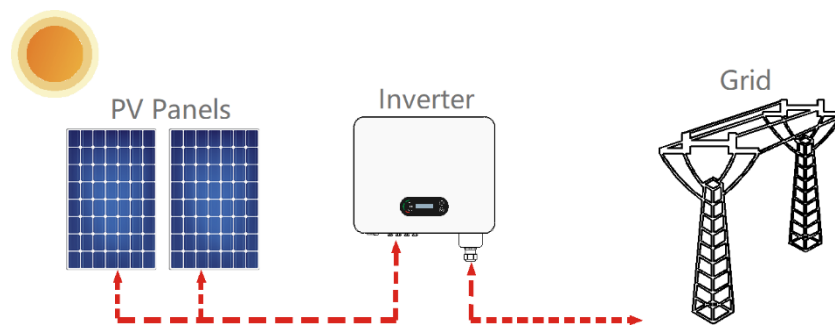

Figure 2 - Grid-connected photovoltaic system

The 3PH 3.3K-12K TL-V3 inverters can only be used with photovoltaic modules that do not require one of the polarities to be grounded. The operating current and voltage during normal operation must not exceed the limits indicated in the technical specifications. Only photovoltaic modules can be connected to the input of the inverter (do not connect batteries or other power supply sources).

#### Intended grids

The 3PH 3.3K-12K TL-V3 inverters are compatible with grid configurations TN-S, TN-C, TN-C-S, TT, IT. For the type of TT electrical grid, the voltage between neutral and ground must be less than 30V. The figure below shows the diagrams of the grids just described.

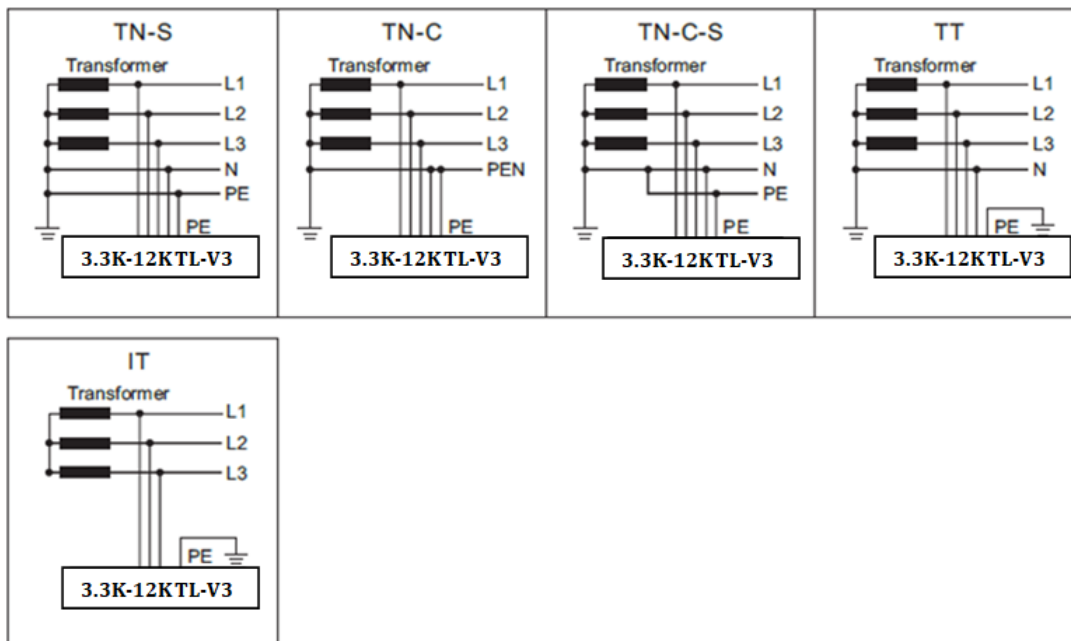
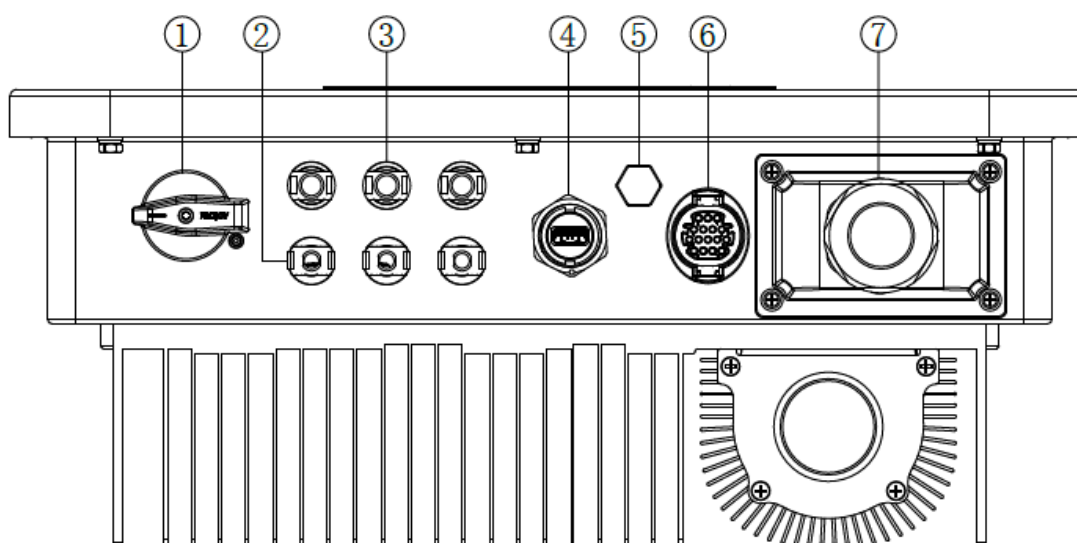

Figure 3 - Wiring diagrams of grid types on which the 3PH 3.3K-12K TL-V3 inverters can be installed

## Inverter components



1. DC switch
2. DC positive pole connectors
3. DC negative pole connectors
4. USB Port (for Wi-Fi / Ethernet / 4G communication)
5. Anti-condensation valve
6. COM Port (for RS485 communication)
7. AC output terminal

- The inverter model must be chosen by a qualified technician who knows the installation conditions, the devices that will be installed outdoors and the possible integration with existing systems.
- Optional components of the inverter should be chosen by a qualified technician who is familiar with the installation conditions.
- Overall dimensions: H x W x D = 430 mm x 385 mm x 182 mm

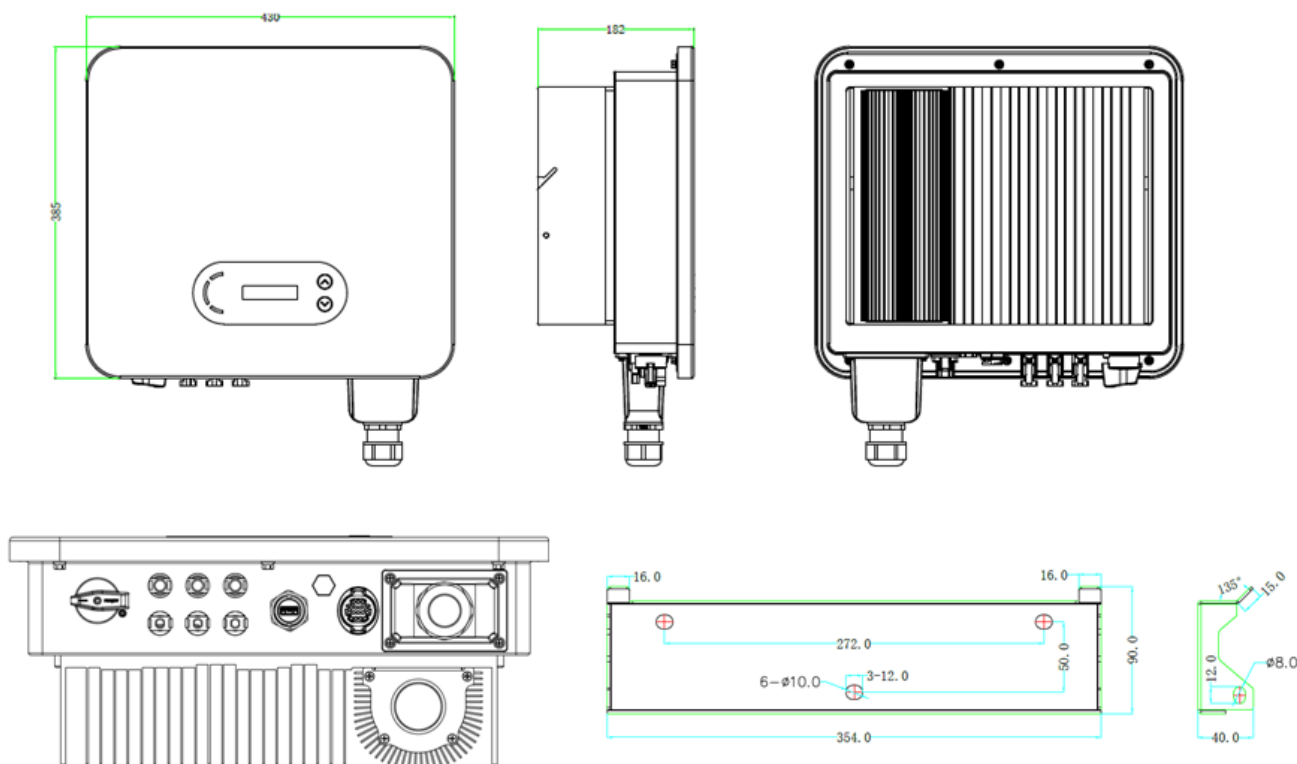
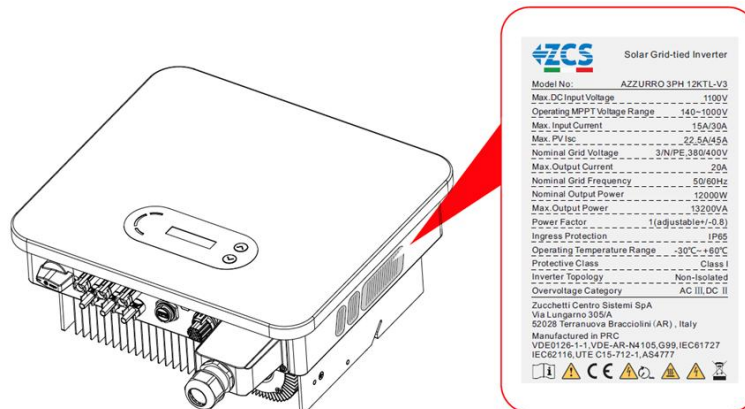

Figure 4 - Front, side and back view of the inverter and bracket



- **Labels on the inverter**



**Figure 5 – Do not remove the label on the side of the inverter**

## 2.2. Description of functions

The DC voltage generated by the PV modules is filtered through the input board before entering the power board. The input board also has the function of measuring the insulation impedance and the DC input voltage/current. The power board converts the DC power into AC power. The current converted into AC is filtered through the output board and is then fed into the grid. The output board also has the function of measuring the grid and GFCI voltage/current and of piloting the output insulation relays. The control board provides the auxiliary power supply, controls the operating status of the inverter and shows it on the display. The display also shows the error codes when the inverter is not functioning properly. At the same time, the control board can activate the protection relay in order to protect the internal components.

### Operating principles

- The DC switch disconnects the internal circuits from the DC input for maintenance purposes.
- Electromagnetic filters (EMI) at the input and output filter the electromagnetic emissions of the inverters to ensure that they meet the electromagnetic compatibility requirements.
- The input board measures the insulation impedance, voltage and current of the various strings; it also manages the algorithm of the maximum power point algorithm (MPPT) to maximum the power generated by the photovoltaic strings.
- The DC-AC conversion circuit converts the DC power into AC power and feeds it into the grid, complying with requirements of local regulations.
- The insulation relay disconnects the inverter from the electrical network.
- The communication board allows the inverter to communicate via RS485 and Wi-Fi (optional); the user can access all operating data via web portal from a PC and via APP.

## **Inverter functions**

### **A. Energy management unit**

#### **A.1 Feeding reactive power into the grid**

The inverter is capable of generating reactive power and can then feed it into the grid by setting the Power Factor. The feed-in management can be controlled directly by the grid operator via a dedicated RS485 serial interface.

#### **A.2 Limiting the active power fed into the grid**

If properly set, the inverter can limit the amount of active power fed into the grid at the desired value (expressed as a percentage). To achieve this limitation, it is necessary to use an external device (Anti-Reverse Power Controller) not included with the inverter.

#### **A.3 Automatic power reduction when grid is over frequency**

When the grid frequency exceeds the limit set, the inverter reduces the power in order to ensure the stability of the grid.

#### **A.4 Power reduction due to environmental conditions, input and output voltage**

The power reduction value and temperature of the inverter at which it occurs depends on the ambient temperature and on many operating parameters, such as: input voltage, grid voltage and power available from the photovoltaic field. The inverter can therefore reduce the power at certain times of the day and depending on the value of these parameters.

### **B. Data transmission**

The inverter (or a group of inverters) can be monitored remotely via an advanced communication system based on a RS485 interface or via Wi-Fi.

### **C. Software update**

The USB port is used to update the firmware.

## **2.3. Module protection**

### **A. Anti-islanding**

The inverter is equipped with a protection system which automatically shuts down the system during power outages. This is called an “anti-islanding” system. This protects electrical workers when they are trying to repair lines on the grid, in compliance with the applicable national laws and regulations.

### **B. RCMU**

The inverters are equipped with a redundancy on the reading of the ground leakage current, on both the direct and alternating current sides. The ground leakage current is measured simultaneously and independently by two different processors: it is sufficient for one of the two to detect a fault in order to trigger the protection, resulting in separation from the grid and shutdown of the operation.

### C. Grid monitoring

Continuous monitoring of the grid voltage to ensure that the voltage and frequency values stay within the operating limits.

### D. Internal protection of the inverter device

The inverter has all kinds of internal protections to protect the device and internal components when abnormal situations occur on the grid or DC input line.

### E. Ground fault protection

The inverter must be used with photovoltaic modules connected with “floating” connections, i.e. with positive and negative terminals that are not grounded. The ground fault condition is indicated by a red LED on the front panel.

## 2.4. Efficiency curve

### Efficiency curve for an Azzurro ZCS 3PH 11K TL-V3 model

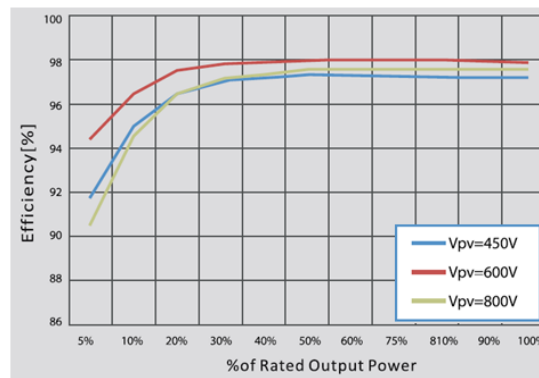





Figure 6 – Efficiency curve for an Azzurro ZCS 11K TL-V3 inverter

### 3. Installation

#### General information in this chapter

This chapter describes how to install the 3PH 3.3K-12K TL-V3 inverter.

#### Installation notes:

	<ul style="list-style-type: none"> <li>• <b>DO NOT</b> install 3.3K-12K TL-V3 inverters near flammable materials.</li> <li>• <b>DO NOT</b> install 3.3K-12K TL-V3 inverters in an area where flammable or explosive materials are stored.</li> </ul>
<b>Danger</b>	
	<p>The housing and heat sink may become very hot while the inverter is running, <b>DO NOT</b> install the inverter in places where they may be touched inadvertently.</p>
<b>Warning</b>	
	<ul style="list-style-type: none"> <li>• <b>Consider the weight of the inverter when handling and transporting the inverter.</b></li> <li>• <b>Choose an appropriate mounting position and surface.</b></li> <li>• <b>Assign at least two people to install the inverter.</b></li> </ul>
<b>Attention</b>	

#### A. Installation process

This section describes the process for installing the 3PH 3.3K-12K TL-V3 inverter.

#### B. Checks before installation

This section describes the checks to carry out on the outer packaging, on the inverter and its components.

#### C. Installation tools

This section describes the tools needed to install the inverter and to make the electrical connections

#### D. Installation position

This section describes the characteristics of the installation site of the inverter.

#### E. Moving the inverter

This section describes how to move the inverter to the installation position

## F. Installing the inverter

This section describes the steps for installing the inverter on the wall

### 3.1. Installation process



Figure 7 - Installation steps

### 3.2. Checks before installation

#### Checking the outer packaging

Packaging materials and components may be damaged during transport. Therefore, please check the materials of the outer packaging before installing the inverter. Check the surface of the box for external damage such as holes or tears. If any kind of damage is found, do not open the box containing the inverter and contact the supplier and transport company as soon as possible.

It is recommended to remove the packaged materials from the box 24 hours before installing the inverter.





#### Checking the product

After removing the inverter from its packaging, check that the product is intact and complete. If any damage is found or components are missing, contact the supplier and transport company.



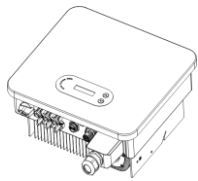
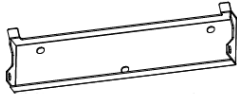

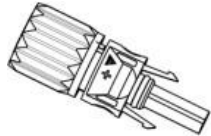
#### Contents of the packaging

Carefully check the contents of the packaging before installation, making sure that no element inside the packaging is missing or damaged.

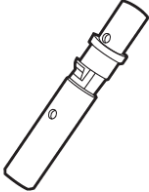
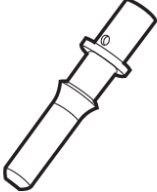
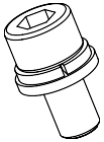
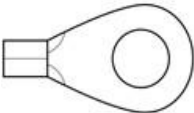
The package should contain the following components:

No	Pictures	Description	Quantity
1		3PH 3.3K-12K TL-V3	1 PCS
2		Rear Panel	1 PCS
3		M6*80 Hexagon screws	3 PCS
4		PV+ input connector	3.3KTL-V3 2 PCS 4.4KTL-V3 2 PCS 5.5KTL-V3 2 PCS 6.6KTL-V3 2 PCS 8.8KTL-V3 2 PCS 11KTL-V3 2 PCS 12KTL-V3 3 PCS
5		PV- input connector	3.3KTL-V3 2 PCS 4.4KTL-V3 2 PCS 5.5KTL-V3 2 PCS 6.6KTL-V3 2 PCS 8.8KTL-V3 2 PCS 11KTL-V3 2 PCS 12KTL-V3 3 PCS

6		PV+ metal pin	<p>3.3KTL-V3 2 PCS</p> <p>4.4KTL-V3 2 PCS</p> <p>5.5KTL-V3 2 PCS</p> <p>6.6KTL-V3 2 PCS</p> <p>8.8KTL-V3 2 PCS</p> <p>11KTL-V3 2 PCS</p> <p>12KTL-V3 3 PCS</p>
7		PV- metal pin	<p>3.3KTL-V3 2 PCS</p> <p>4.4KTL-V3 2 PCS</p> <p>5.5KTL-V3 2 PCS</p> <p>6.6KTL-V3 2 PCS</p> <p>8.8KTL-V3 2 PCS</p> <p>11KTL-V3 2 PCS</p> <p>12KTL-V3 3 PCS</p>
8		M6*12 Hexagon screws	1 PCS
9		R-type terminal	5 PCS

10		Communication Terminal	1 PCS
11		Manual	1 PCS
12		Warranty card	1 PCS
13		Quality Certificate	1 PCS



### 3.3. Installation tools

The following tools are required for installation of the inverter and electrical connections; therefore, they must be prepared before installation.





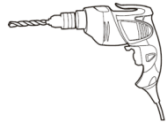
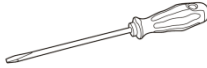
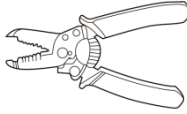
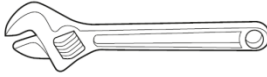
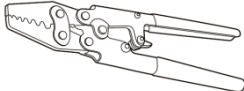

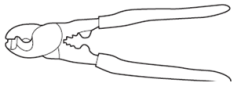
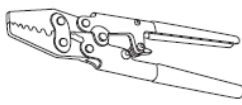
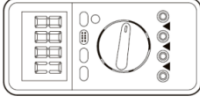

No.	Tool		Function
1		Drill Recommended drill bit: 8mm	To drill holes in the wall for fixing the bracket
2		Screwdriver	To screw and unscrew screws for the various connections
3		Wire stripper	To prepare the cables for wiring
4		Adjustable spanner (opening greater than 32 mm)	To tighten the bolts
5		RJ45 crimping tool	To crimp the RJ45 connectors for the communication cables
6		Rubber hammer	To insert the expansion plugs into the wall holes
7		MC4 removal tool	To remove the DC connectors from the inverter
8		Cable cutter	To cut the power cables
9		Crimping tool	To crimp the power cables
10		Multi-meter	To check the voltage and current values

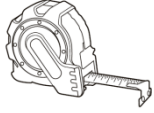
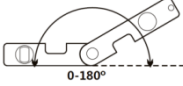
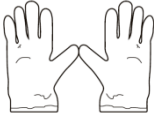

11		Marker pen	To mark the wall for better fixing precision
12		Measuring tape	To measure distances
13		Level	To make sure the bracket is level
14		ESD gloves	Protective clothing
15		Safety goggles	Protective clothing
16		Protection mask	Protective clothing

### 3.4. Installation position

Choose an appropriate installation location for the inverter.

Follow the requirements below to determine the installation position.

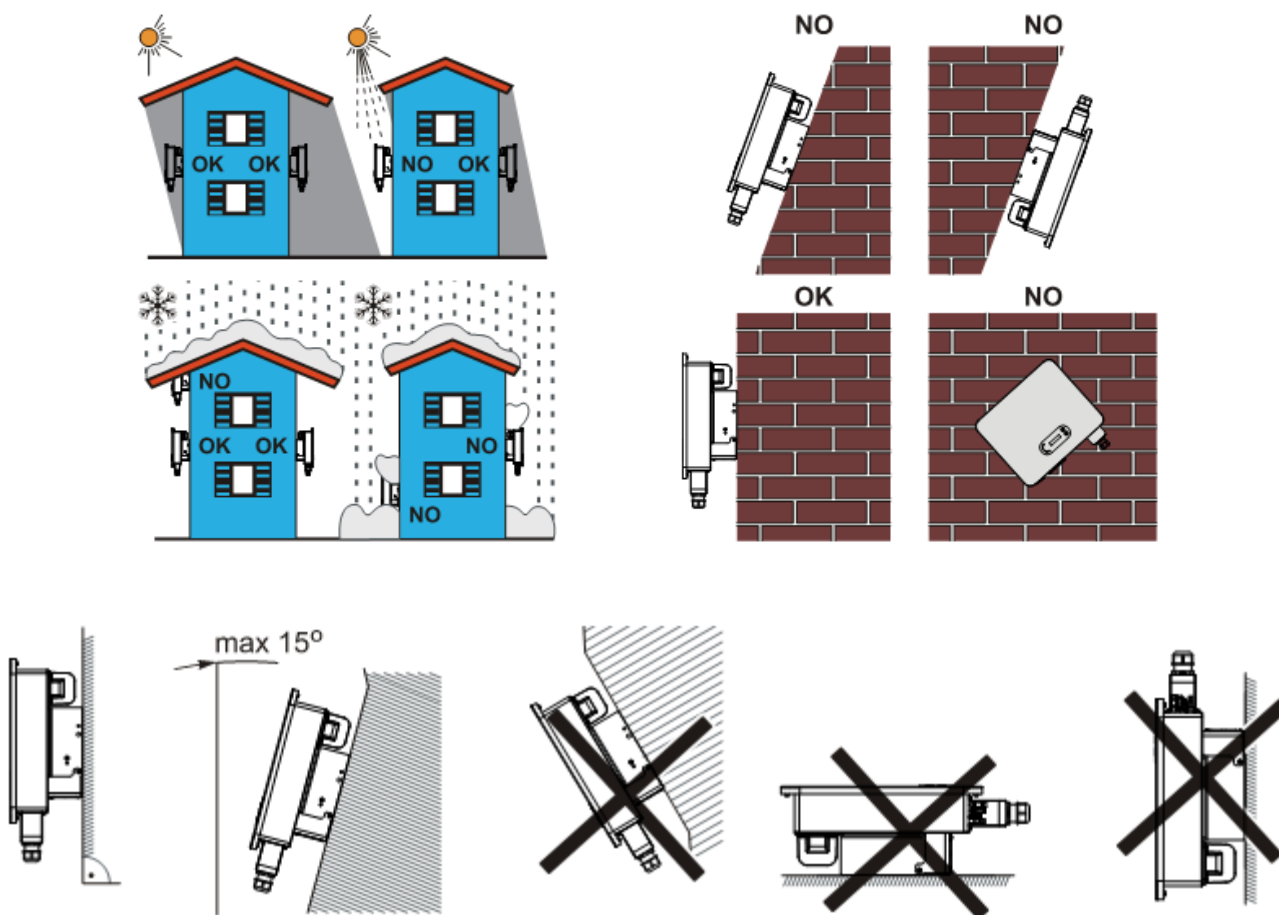
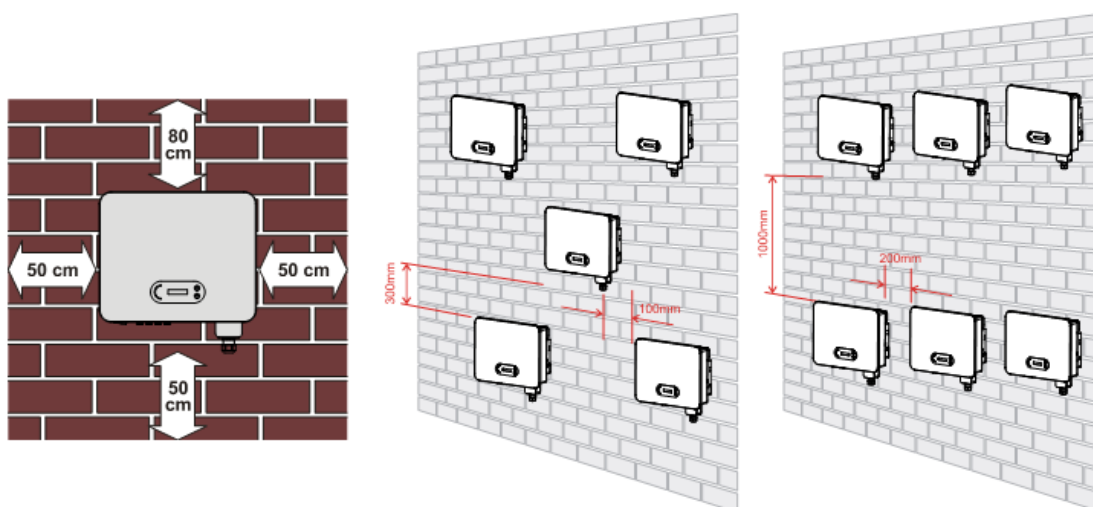

Figure 8 - Requirements for installing a single inverter



**Figure 9 - Requirements for installing multiple inverters**

**Note:** For safety reasons, ZCS Spa and/or its partners may not carry out any technical repairs or maintenance work, or move the inverter from and to the ground if it is installed at a height of more than 180 cm from the ground.

Inverters installed at higher heights must be moved to the ground before they can be repaired or serviced.

### 3.5. Moving the 3PH 3.3K-12K TL-V3 inverter

**This section describes how to move the inverter correctly**

- 1) When opening the packaging, insert your hands into the slots on both sides of the inverter and take hold of it.
- 2) Lift the inverter from its packing box and move it to the installation position, then remove the polystyrene protections.



#### Attention

- To prevent damage and personal injury, hold the inverter firmly when moving, as it is a heavy piece of equipment.
- Do not position the inverter with the input/output terminals in contact with other surfaces, as these are not designed to support the weight of the inverter. Always position the inverter horizontally.
- When placing the inverter on the floor, make sure to place a support under the unit to protect its front door.

### 3.6. Installing the 3PH 3.3K-12K TL-V3 inverter

- 1) Correctly position the mounting bracket on the wall using a level to ensure that it is straight; mark the 3 holes using a suitable marker pen. Keeping the hammer drill perpendicular to the wall and avoiding any sudden movements when drilling, drill the 3 holes at the points marked on the wall using an 8 mm drill bit. In case of errors during drilling, it is necessary to reposition the holes.
- 2) Insert the plugs horizontally into the holes made, paying attention to the force and depth with which they are inserted (make sure the plug completely enters the hole).
- 3) Align the mounting bracket with the position of the holes and fix it to the wall using the screws and flat washers supplied, tightening them properly.
- 4) Place the inverter on the mounting bracket
- 5) Secure the inverter to the mounting bracket with the bolt provided to ensure stability.
- 6) (OPTIONAL) Depending on the customer's requirements, the inverter can be locked to the mounting bracket with a safety lock (not supplied with the kit).

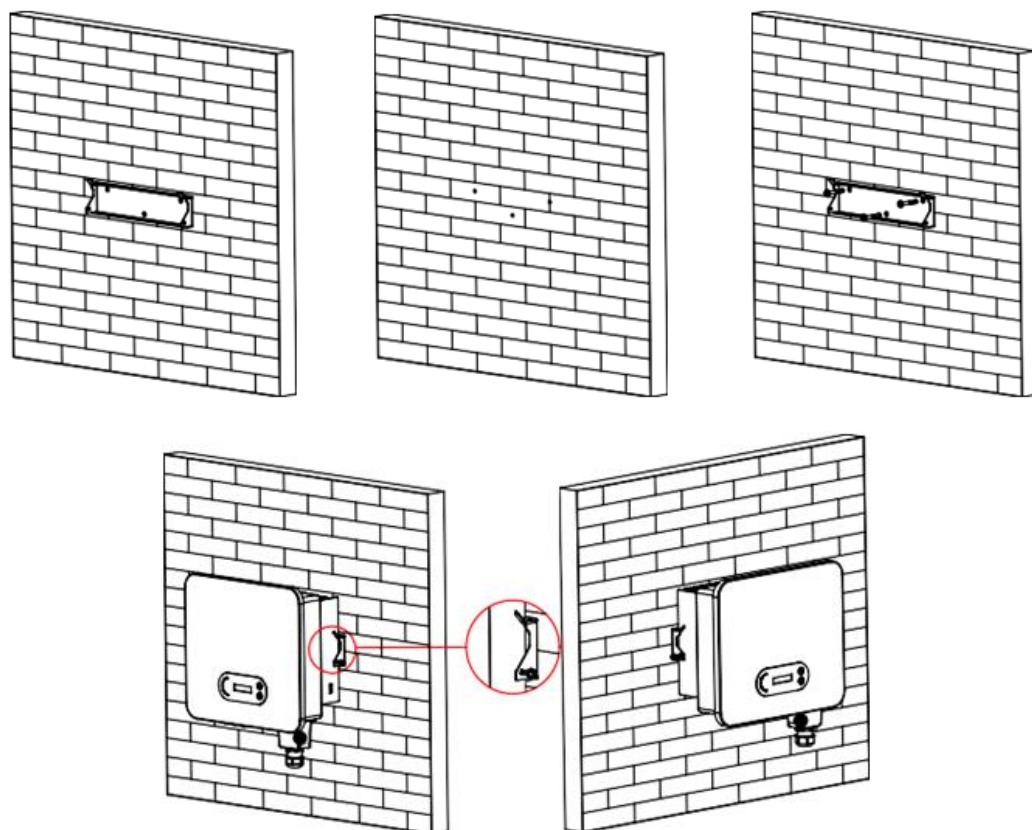





Figure 10 - Steps for mounting the inverter on the wall

## 4. Electrical connections

### General information in this chapter

This chapter describes the electrical connections of the 3PH 3.3K-12K TL-V3 inverter. Carefully read this section before connecting the cables.

**NOTE:** Before making any electrical connections, ensure that the DC and AC circuit breakers are open. Remember that the accumulated electrical charge remains in the inverter capacitor after the DC and AC circuit breakers have been switched off. Therefore, it is necessary to wait at least 5 minutes to allow the capacitor to discharge completely.

	<b>The inverter must be installed and serviced by professional technicians or electricians.</b>
<b>Attention</b>	
	<b>The PV modules generate electricity when exposed to sunlight, which can pose a risk of electric shock. Before connecting the DC input power cord, be sure to disconnect the strings via the appropriate circuit breakers.</b>
<b>Danger</b>	
	<p><b>The maximum open-circuit voltage of the photovoltaic string must be less than 1100 V.</b></p> <p><b>The 3PH 3.3K-12K TL-V3 series has two independent input channels (MPPT); all the photovoltaic modules connected to them must be of the same model and brand. They must have the same number of photovoltaic modules connected in series and have the same orientation (solar azimuth and inclination angle).</b></p>
<b>Note</b>	

## 4.1. Electrical connections



Figure 11 – Steps for connecting the cables

## 4.2. Connecting PNGD cables (grounding)

Connect the 3PH 3.3K-12K TL-V3 inverter to the ground electrode using ground protection cables (PGND).

	<p>The inverter does not have a transformer, therefore the positive and negative polarities of the photovoltaic string do NOT need to be grounded. Otherwise, the inverter may fail. All non-current-carrying metal parts (such as the PV module frame, PV rack, housing of the combiner box, and housing of the inverter) in the PV power system must be connected to the ground.</p>
<b>Attention</b>	

**Note:** Connect the PGND cable before connecting the AC, DC power and communication cables.

For systems with one inverter, connect the PGND cable to the ground. For systems with multiple inverters, connect the PGND cables of each inverter to the ground electrode using equipotential connections.

If the installation place is near the ground, connect the PGND cable to the ground before installing the inverter on the wall.

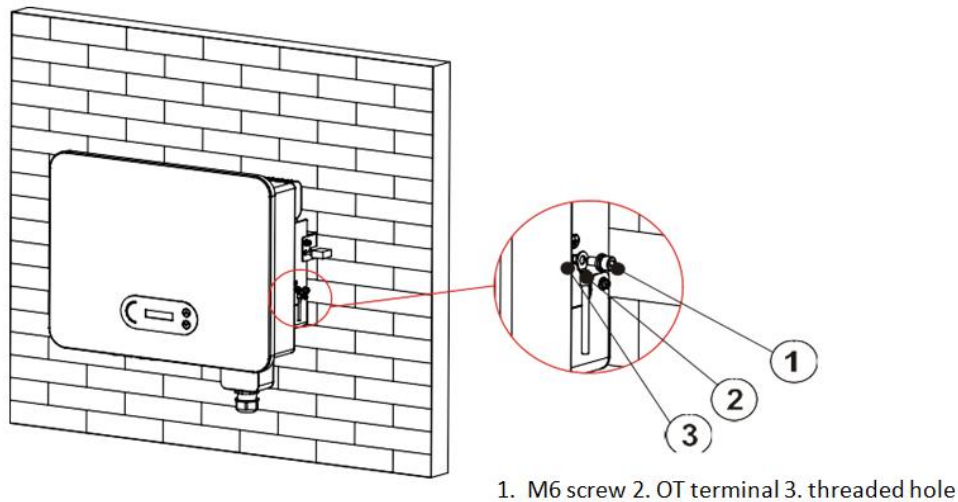

Figure 12 - Connecting the ground terminal

**Prerequisites:**

Prepare the PGND cables to be connected (outdoor power cables with a cross-section of 8 mm<sup>2</sup> are recommended for grounding purposes); it is recommended to use yellow-green cables for better identification.

**Procedure:**

- 1) Remove an adequate length of the external insulation layer using a wire stripper, as shown in Figure 13.

**Note:** L2 is approximately 2-3 mm longer than L1

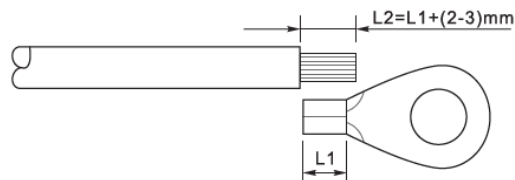

Figure 13 - Preparing the ground cable (1)

- 2) Insert the exposed wires in the OT terminal and crimp them using a crimping tool, as shown in Figure below.

**Note 1:** L3 is the length between the insulation layer of the ground cable and the crimped part. L4 is the distance between the crimped part and the conductor wires protruding from the crimped part.



**Note 2:** The cavity formed after the conductor has been crimped must completely wrap the conductor wires. The core of the wire must be in close contact with the terminal.

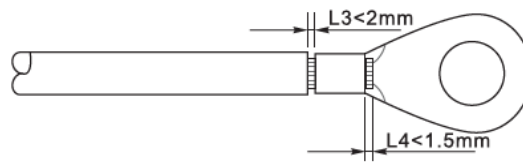

Figure 14 – Preparing the ground cable (2)

- 3) Install the crimped OT terminal and flat washer using the M6 screw in the hole located on the inverter heatsink, as shown in the figure; tighten the screw to a torque of 5 Nm using an Allen key.

**Note:** To ensure the anti-corrosion performances of the ground terminals, apply silica gel on them after connecting the ground cable.

### 4.3. Connecting the DC input power cables

Connect the 3PH 3.3-12K TL-V3 inverter to the photovoltaic strings using DC input power cables. Select the input mode: the 3PH 3.3-12K TL-V3 inverter has two MPPTs, which can function either independently or in parallel, depending on how the system was designed. The user can choose the appropriate MPPT operating mode.

#### Independent mode (default):

If the strings are independent (e.g. installed on two separate flaps), the input model must be set to “independent mode.”

The setting method is described in relative section.

#### Parallel mode:

If the strings are connected in parallel, the input mode must be set to “parallel mode.”

The setting method is described in relative section.

**Note:** Depending on the type of inverter, select the appropriate accessories (cables, fuse holder, fuse, switch, etc). The open-circuit voltage of the photovoltaic system must be lower than the maximum allowable DC input voltage of the inverter. The positive and negative polarities of the panels on the inverter must be connected separately. The power cable must be suitable for photovoltaic applications.



Type	3.3K TL - V3	4.4K TL - V3	5.5K TL - V3	6.6K TL - V3	8.8K TL - V3	11K TL - V3	12K TL - V3
Voltage range per MPPT	160V- 850V	190V- 850V	240V- 850V	290V- 850V	380V- 850V	420V- 850V	420V- 850V
Maximum input voltage	1100V						



The positive and negative polarities of the panels on the inverter must be connected separately. The power cable must be suitable for photovoltaic applications.

**Note:** Both MPPT inputs of the inverter should be populated, even if the system only has one string. If the strings are arranged in parallel, it is recommended to use a Y or T connection cable to double the input currents from the PV field and to populate both MPPT inputs of the inverter, as shown in the figure. If the string arrangement is independent, simply connect the two strings to the two MPPTs of the inverter.



Figure 15 – Y-branch connection cable for solar panels

	<ul style="list-style-type: none"> <li>• Check the polarity of the PV string to ensure the correct connection of the cables to the string.</li> </ul>
<p>Note</p>	<ul style="list-style-type: none"> <li>• Do not connect the positive or negative polarities of the PV string to the ground.</li> </ul>
	<p><b>Make sure that the following information is observed. Otherwise, there is a risk of fire.</b></p> <ul style="list-style-type: none"> <li>• The modules connected in series in each string must have the same brand and model.</li> <li>• The open-circuit voltage for each string must be less than or equal to 1100 V DC.</li> <li>• The output power for each PV string must be less than or equal to the maximum input power allowable for 3PH 3.3K-12K TL-V3 inverters.</li> </ul>
<p>Attention</p>	<ul style="list-style-type: none"> <li>• The positive and negative terminals of the PV strings must be connected respectively to the positive and negative inputs of the input terminal block.</li> </ul>

	<ul style="list-style-type: none"> <li>• Before connecting the power supply, be sure to disconnect the generator's DC switch. When exposed to the sun, the photovoltaic generator produces a voltage that can be dangerous!</li> </ul>
<b>Danger</b>	<ul style="list-style-type: none"> <li>• Before connecting the power supply, make sure that the voltage of the DC cables is within the permissible operating range, and that the DC circuit breaker switch is open. Otherwise, the high voltage may cause serious damage.</li> </ul>
	<ul style="list-style-type: none"> <li>• If the DC voltage has a non-zero value between the positive terminal of the PV strings and the ground, the PV strings are subject to insulation faults. Fix the fault before connecting the cables.</li> </ul>
<b>Note</b>	

### Context

Cross section (mm <sup>2</sup> / AWG)		Outer diameter of cable (mm)
Range	Recommended value	
4.0-6.0 / 11-9	4.0 / 11	4.5 - 7.8

Table 1 - Recommended specifications for DC input cables

The DC input connectors (MC4) are classified into positive and negative connectors, as shown in the figures below.

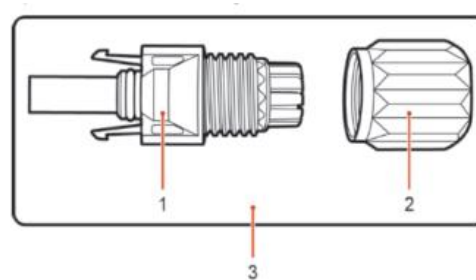

1. Housing 2. Cable gland 3. Positive connector

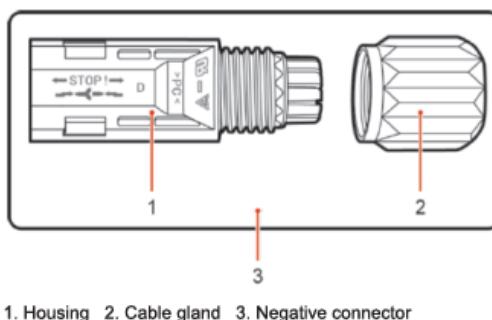

Figure 16 – Positive (1) and Negative (2) MC4 connectors

### Note

The positive and negative metal terminals are packed together with the positive and negative connectors respectively. Separate the positive and negative metal terminals after unpacking the inverter so as to avoid confusing the polarities.

### Procedure

- 1) Remove the cable glands from the positive and negative connectors.
- 2) Remove an appropriate length of the insulation layer from the positive and negative power cables by using a wire stripper, as shown in the figure.

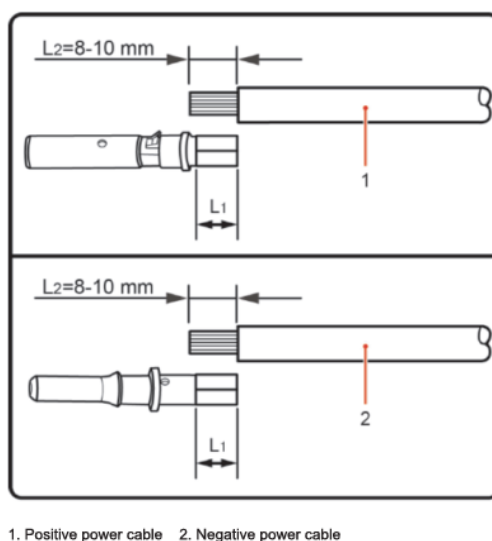

Figure 17 – Connecting the DC input power cables (1)

**Note:** L2 is approximately 2 or 3 mm longer than L1.

- 3) Insert the positive and negative power cables in the corresponding cable glands.
- 4) Insert the stripped positive and negative power cables in the positive and negative metal terminals respectively, and crimp them using a suitable tool. Make sure that the cables are secured so that they cannot be pulled out with a force of less than 400 N, as shown in Figure below

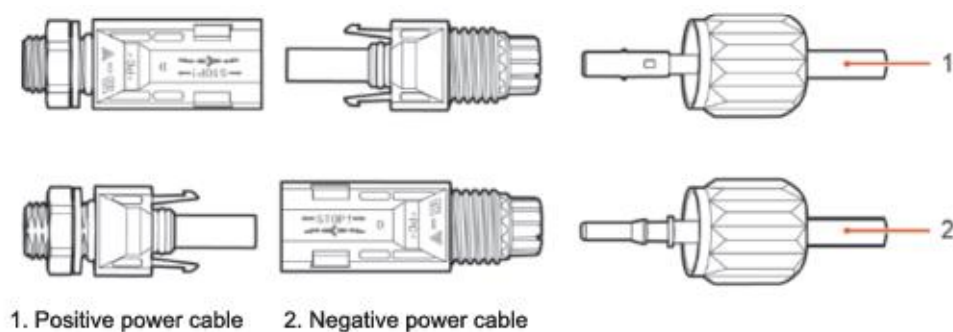

Figure 18 - Connecting the DC input power cables (2)

- 5) Insert the crimped power cables in the corresponding seats until you hear a “click” sound. At that point, the power cables will snap into place.
- 6) Replace the cable glands on the positive and negative connectors and rotate them against the insulation covers.
- 7) Insert the positive and negative connectors in the corresponding DC input terminals of the inverter until you hear a “click” sound, as shown in the figure.

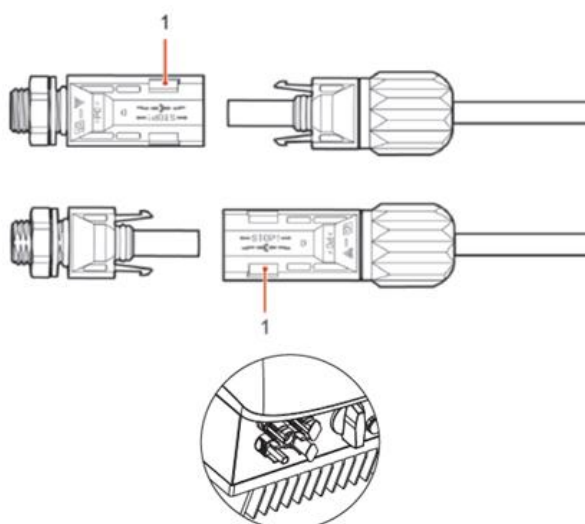



Figure 19 - Connecting the DC input power cables (3)

**Note:** Insert the caps into the unused DC connectors.

### Removal procedure

To remove the positive and negative connectors from the inverter, insert a removal tool into the bayonet coupling and press the tool with adequate force, as shown in the figure below.

	<p><b>Before removing the positive and negative connectors, make sure that the</b></p>
---	--

<b>Warning</b>	inverter's circuit breaker is switched off. If not, the direct current may cause an electric arc that could result in a fire
----------------	--

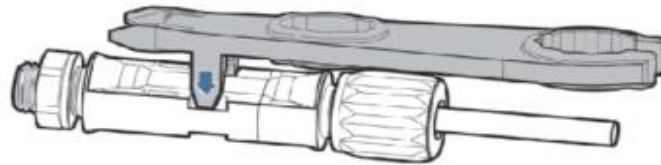



Figure 20 - Removing the DC connector

#### 4.4. Connecting the AC output power cables

Connect the inverter to the AC power distribution network or power grid using AC power cables.

	<ul style="list-style-type: none"> <li>Do not use the same AC circuit breaker for multiple inverters.</li> <li>Do not install loads between the inverter and the AC circuit breaker.</li> <li>The switch used as a disconnection device should always be operational and ready to operate.</li> <li>In Italy, each grid-connected photovoltaic system with a power output of more than 11.08 kW must be equipped with an external interface device (SPI)</li> </ul>
<b>Warning</b>	

#### Context

All the AC power cables used for the inverter must be 5-pole outdoor cables. For easier installation, use flexible cables. The table lists the recommended specifications for cables and circuit breakers.

Type	3.3K TL-V3	4.4K TL-V3	5.5K TL-V3	6.6K TL-V3	8.8K TL-V3	11K TL - V3	12K TL - V3
Cable (mm <sup>2</sup> )	2.5-6	2.5-6	2.5-6	2.5-6	4-6	4-6	4-6
Switch	16A	16A	16A	20A	25A	32A	32A

Table 2 - Recommended specifications for AC-side switches

**Note:** For safety reasons, make sure to use suitably sized cables, otherwise the current may cause overheating or overloading, which could result in a fire.

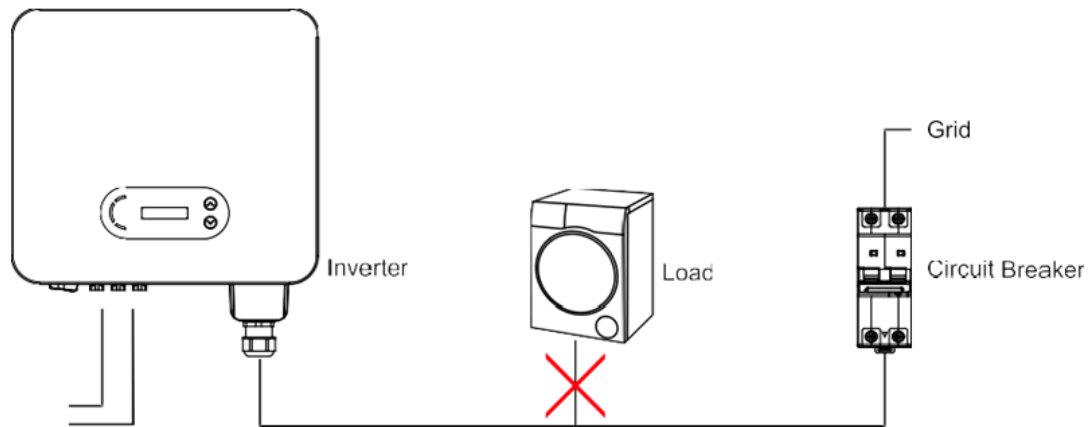

**Figure 21 - Do not connect loads between the inverter and circuit breaker**

### Multi-core copper cables

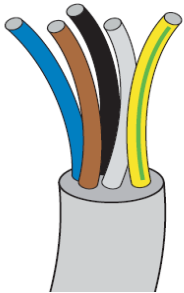

The cross-section of the power line must be sized in order to prevent unwanted disconnections of the inverter from the grid due to high impedance of the cable connecting the inverter to the point of supply. In addition, the AC cable must be correctly sized to ensure that the loss of power on the cable is less than 1% of the rated power and to ensure the proper functioning of the anti-islanding protection. The cable length from the inverter to the grid should not exceed 150 metres.

The figure below shows the relationship between the power loss in the cable, its length and the cross-section area.

Cross section of cables (mm <sup>2</sup> / AWG)	Maximum length (m)					
	4.4K TL-V3	5.5K TL-V3	6.6K TL-V3	8.8K TL-V3	11K TL-V3	12K TL-V3
<b>2.5 / 13</b>	50	40	33	-	-	-
<b>4 / 11</b>	80	60	50	40	32	26
<b>6 / 9</b>	120	96	80	60	48	40

**Table 3 - Recommended specifications for AC output cables**

The 3.3K-12K TL-V3 inverters are three-phase output inverters that comply fully with the local grid connection requirements and safety standards.

The inverters are equipped with AC output connectors with IP66 protection suitable for photovoltaic use; customers must provide their own AC output cable connections.

### Cable connection procedure

- 1) Identify the suitable cable section as shown in the table and remove an appropriate length of the protective sheath, as shown in the figure (A: 30~50 mm B: 3~5 mm).

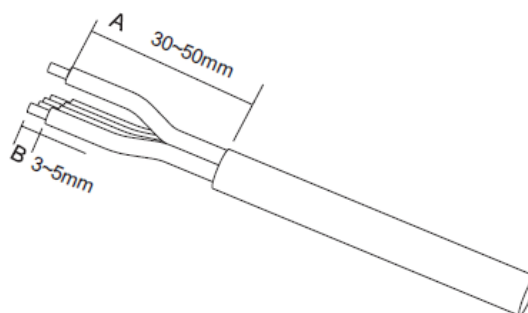

Figure 22 - Connecting the AC output cables (1)

- 2) Disassemble the AC connector as shown in the figure below; insert the AC output cable (with its stripped insulation layer as shown in step 1) through the PG waterproof cable gland.

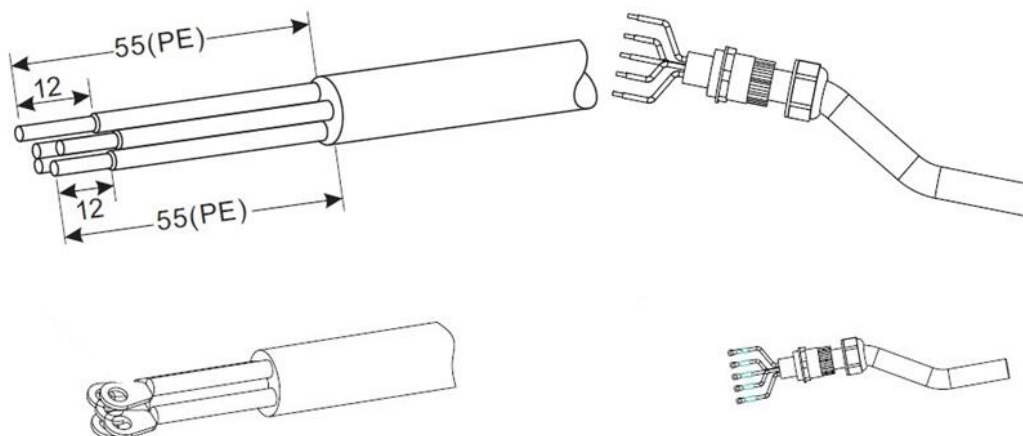

Figure 23 - Connecting the AC output cables (2)

- 3) Connect the AC power cable according to the following criteria:
  - Connect the yellow-green wire (ground) to the hole labelled “PE”, and tighten the wire with an Allen key;
  - Connect the R-phase wire to the hole labelled “R”, and tighten the wire with a screwdriver;
  - Connect the S-phase wire to the hole labelled “S”, and tighten the wire with a screwdriver;
  - Connect the T-phase wire to the hole labelled “T”, and tighten the wire with a screwdriver;
  - Connect the blue (neutral) wire to the hole labelled “N”, and tighten the wire with a screwdriver;
  -



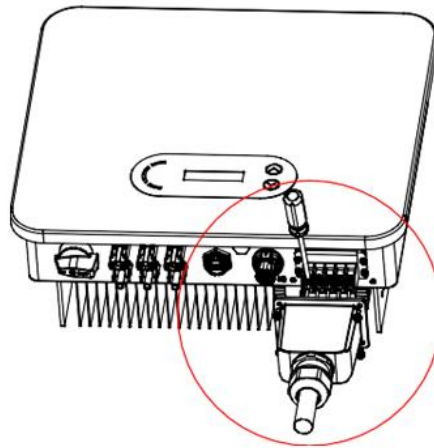

Figure 24 - Connecting the AC output cables (3)

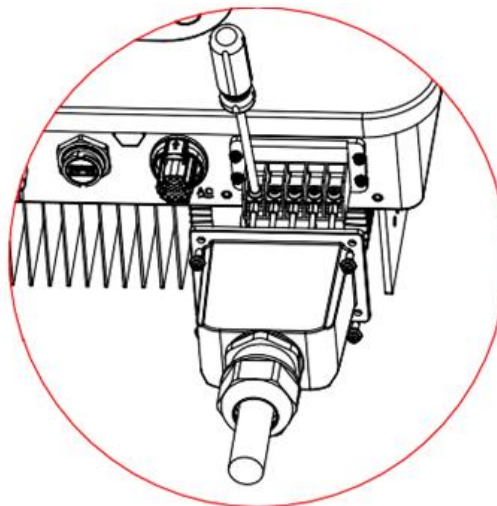

Figure 25 - Connecting the AC output cables (4)

#### 4.5. Connecting the communication cables

The 3PH 3.3K-12K TL-V3 inverters have two communication interfaces, the USB interface and the port COM, as shown in the figure below.

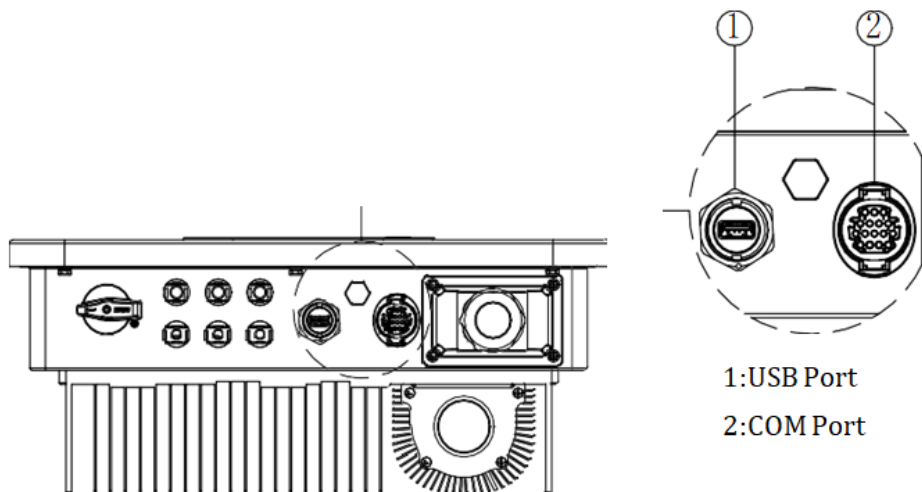

Figure 26 – Bottom view of the inverter with RS485 (1) and COM port (2)

#### USB port

<b>USB port</b>	USB flash disk access	Use for updating the software
	USB acquisition stick (WIFI / Ethernet / 4G) access	Use for remote data acquisition and upgrading of inverter

## Procedure

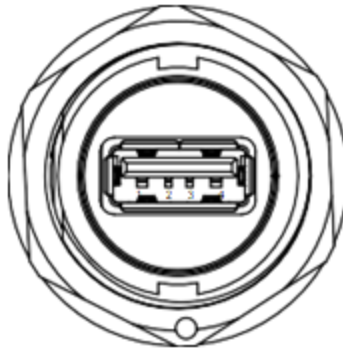

Figure 27 – USB port connector

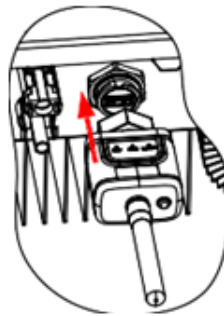

Figure 28 – USB stick mounting (1)

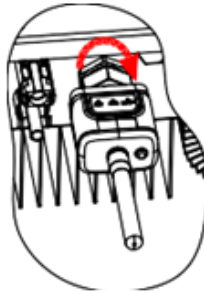

Figure 29 – USB stick mounting (2)

## COM port

Recommended cable size for the COM port.

Name	Type	Outer diameter (mm)	Area (mm <sup>2</sup> )
RS485 Communication Wire	Outdoor shielded twisted pair meets local standards	2 or 3core: 4~8	0.25~1

COM port description.

PIN	Define	Function	Note
1	RS485A	RS485 signal+	Wire connection monitoring or multiple inverter monitoring
2	RS485A	RS485 signal+	
3	RS485B	RS485 signal-	
4	RS485B	RS485 signal-	
5	Electric meter RS485A	Electric meter RS485 signal+	Wire connection Electric meter
6	Electric meter RS485B	Electric meter RS485 signal-	
7	GND.S	Communication ground	As RS485 signal ground or DRMS port ground
8	DRM0	Remote shunt down	DRMS port
9	DRM1/5	DRMS port logical IO	
10	DRM2/6		
11	DRM3/7		
12	DRM4/8		
13-16	Blank PIN	N/A	N/A

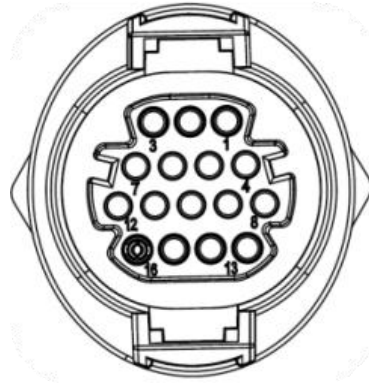

Figure 30 - COM connector

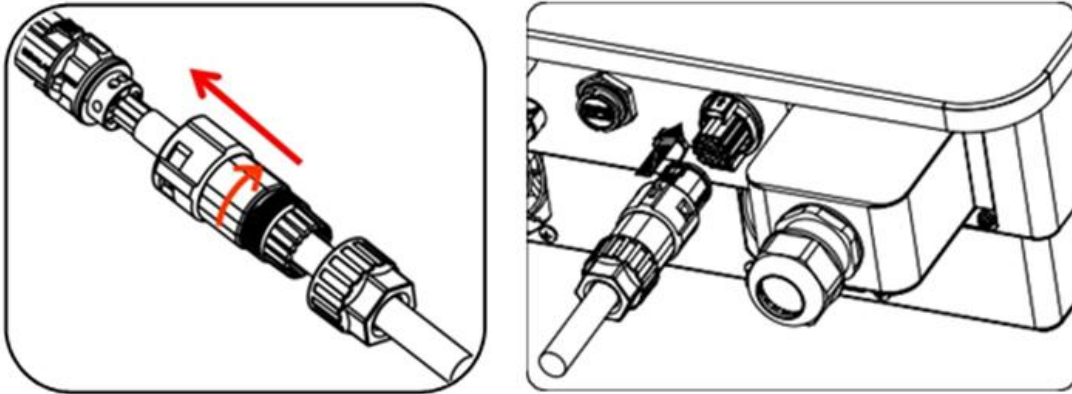



Figure 31 - COM connector installation

## 5. Commissioning the inverter

### 5.1. Safety inspection before commissioning

	<p><b>Make sure that the DC and AC voltages fall within the range permitted by the inverter.</b></p>
<p><b>Attention</b></p>	

- **Photovoltaic strings**  
Before turning on the inverter, the photovoltaic string must be examined. Check the open-circuit voltage of each photovoltaic panel and compare it with the data in the technical datasheet.

  - Make sure that the open-circuit voltage of each PV string corresponds to the technical data;
  - Make sure that the positive and negative polarities are correct.
- **DC connection**  
Make sure that the DC switch of the inverter is off. Use the multi-meter to check the voltage and current on the DC side; check the DC cable, make sure that the positive and negative polarities are not inverted, and are consistent with the positive and negative polarities of the photovoltaic string; otherwise, the inverter may suffer irreparable damage. polarities the voltage of each string connected to the same MPPT; if the difference is more than 3%, the PV string may be damaged. The maximum DC voltage (if the minimum operating temperature allowable is reached) must be less than 1100 V. Make sure that all the photovoltaic strings are securely connected to the input of the inverter.
- **AC connection**  
Make sure that the AC switch of the inverter is off. Check that the phases of the inverter are correctly connected to the grid (R, S, T, N, PE). Check that the type of AC grid in which the inverter is installed is correct (TN-C, TN-S, TT). Check that the voltage of each phase is within the correct range. If possible, measure the THD; if there is too much distortion, the inverter may not operate properly.
- **Installing the front cover and the clamping screws**

## 5.2. Starting the inverter

- 1) Turn ON the DC switch both on the field panel and on the photovoltaic inverter (if present); wait for the screen to turn on.
- 2) Turn ON the AC switch installed on the wall.  
When the photovoltaic string generates enough direct current, the inverter will start automatically. The word “normal” shown on the screen indicates the correct functioning of the inverter.
- 3) Set the correct country code (refer to related chapter of this manual).

Note: Different grid operators in different countries require different specifications regarding the grid connections of PV inverters. Therefore, it is very important to select the correct country code according to the requirements of the local authorities.

If in doubt, consult the system engineer or a qualified electrician.

Zucchetti Centro Sistemi S.p.A. shall not be held responsible for any consequences resulting from the incorrect selection of the country code.

If the inverter indicates the presence of any faults, refer to related chapter of this manual or contact the Zucchetti Centro Sistemi S.p.A. technical support.

## 6. Operating interface

### General information in this chapter

This section describes the display and its operation, as well as the buttons and LED indicators of the 3PH 3.3K-12K TL-V3 inverters.

### 6.1. Operating panel and display

#### Buttons and LED indicators

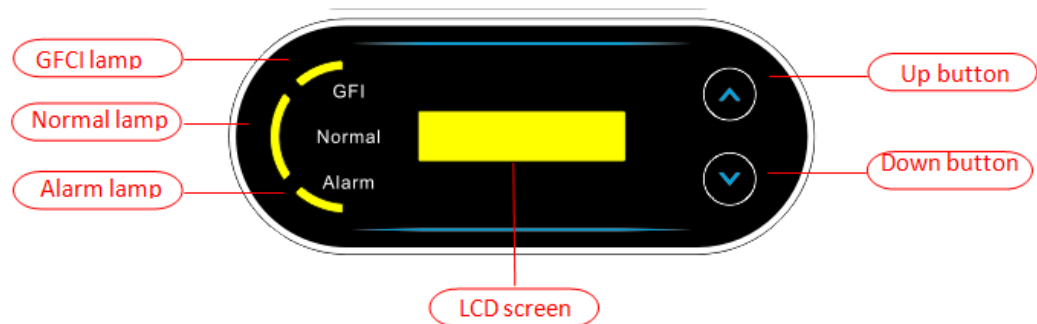

Figure 32 - LCD display with buttons and LED indicators

#### Main buttons:

- “^” Short press UP button = go up
- “^” Long press UP button = exit menu or current interface
- “v” Short press DOWN button = go down
- “v” Long press DOWN button = enter menu or current interface

#### Indicator lights:

- “GFI” Red light ON = GFCI faulty
- “Normal” Green light flashing = counting down or checking
- “Normal” Green light ON = Normal
- “Alarm” Red light ON= recoverable or unrecoverable faulty



## 6.2. Main interface

LCD interface indicated inverter status, alarm information, communication connection, PV input current and voltage, grid voltage, current and frequency, today generation, total generation.

Inverter working status, PV 1 input voltage and current.

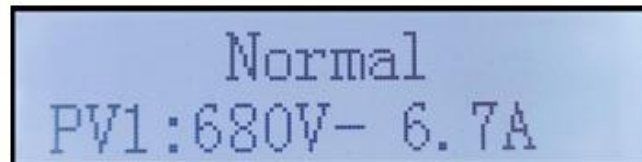

Normal  
PV1: 680V - 6.7A

Inverter working status, PV 2 input voltage and current.

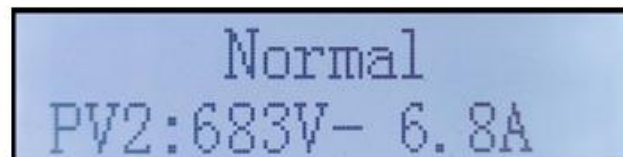

Normal  
PV2: 683V - 6.8A

Inverter working status, PV generated power.



Normal  
Power: 9.07kW

Inverter working status, today generated electricity.

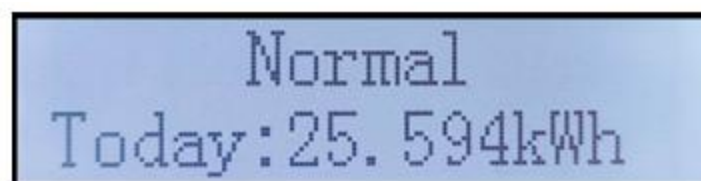

Normal  
Today: 25.594kWh

Inverter working status, total generated electricity.

Normal  
Total: 25.4kWh

Inverter working status, grid voltage and current.

Normal  
GridR: 225V-13.5A

Normal  
GridS: 228V-13.4A

Normal  
GridT: 224V-13.4A

Inverter working status, grid voltage and frequency.

Normal  
Grid: 226V-50.0Hz

Inverter working status, USB status.



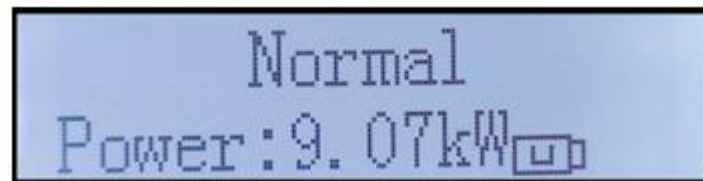

Inverter faulty alarm.

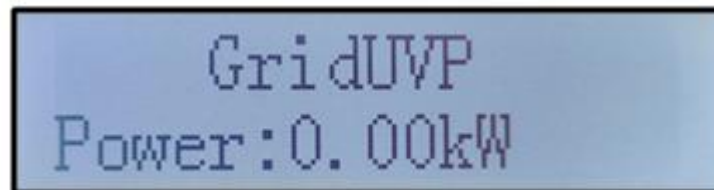

When control board successfully connected with communication board, the LCD display the current state of the inverter, display as shown in the figure below.

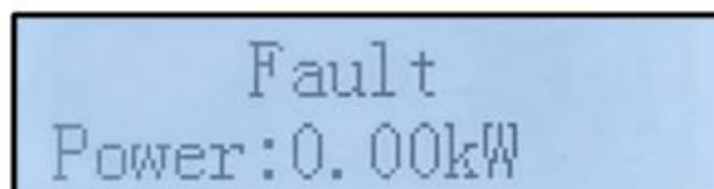
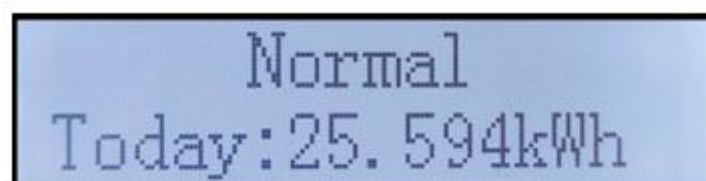
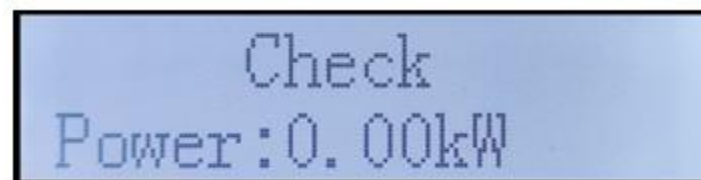
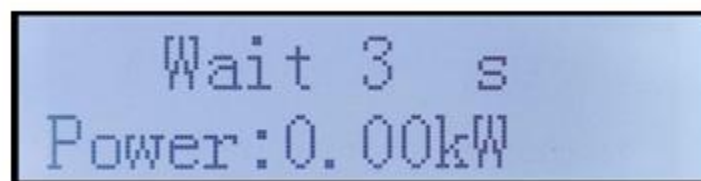

Inverter states includes: wait, check, normal and fault.

### **Inverter statuses include:**

**Wait:** the inverter is waiting for the control status at the end of the reconnection time. In this state, the PV voltage must be higher than 250 V, the grid voltage value must be between the minimum and maximum permissible limits, as should the other grid parameters; otherwise, the inverter will go into an error state.

**Check:** the inverter is checking the insulation resistance, relays and other safety requirements. It also runs a self-test to ensure that the software and hardware of the inverter are functioning properly. The inverter switches to the error state or permanent error state if an errors occur.

**Normal:** The inverter is functioning normally and is feeding power into the grid; the inverter will go into a permanent error state if any faults are found.

**Fault:** Fault State: Inverter has encountered recoverable error. It should recover if the errors disappear. If Fault State continues; please check the inverter according error code.

When the control board and communication board connection fail, the LCD display interface as shown in the figure below.

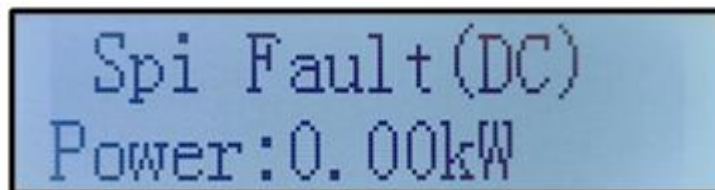

### 6.3. Main menu

Long press the down button under standard interface to enter into main interface, Main interface including below information:

Normal	-----Long press DOWN button
	1.Enter Setting
	2.Event List
	3.SystemInfo
	4.Display Time
	5.Software Update

#### (A) Enter setting Interface as below

1.Enter Setting	-----Long press DOWN button
	1.Set time
	2.Clear Energy
	3.Clear Events
	4.Country Code
	5.On-Off Control
	6.Set Energy
	7.Set Address
	8.Set Input mode
	9.Set Language
	10.MPPT Scan
	11.Logic Interface
	12.Set Power Ratio

Long press the button to Enter the main interface of "1. Enter Setting" and long press to enter the setting menu. You can select the content you want to set by short pressing the button.

Note1: Some settings need to enter the password (the default password is 0001), when entering the password, short press to change the number, long press to confirm the current number, and long press after entering the correct password. If "password error, try again" appears, you will need to re-enter the correct password.

- **Date and time**

Set the system time for the inverter.

- **Clear Energy**

Clean the inverter of the total power generation.

- **Clear Events**

Clean up the historical events recorded in the inverter.

- **Country code**

User can modify the Safety parameters of the machine through the USB flash disk, and the user needs to copy the parameter information that needs to be modified into the USB flash disk card in advance.

**Note:** to enable this feature, please contact the technical support .

Code		Country	Code		Country
000	000	Germany VDE4105	018	000	EU EN50438
	001	Germany BDEW		001	EU EN50549
	002	Germany VDE0126	019	000	IEC EN61727
001	000	Italia CEI-021 Internal	020	000	Korea
	001	Italia CEI-016 Italia	021	000	Sweden
	002	Italia CEI-021 External	022	000	Europe General
	003	Italia CEI0-21 In Areti	024	000	Cyprus
002	000	Australia	025	000	India
	001	Australia AU-WA	026	000	Philippines
	002	Australia AU-SA	027	000	New Zealand
	003	Australia AU-VIC	028	000	Brazil
	004	Australia AU-QLD		001	Brazil LV
	005	Australia AU-VAR		002	Brazil 230
	006	Australia AUSGRID		003	Brazil 254
	003	000	Spain RD1699	029	000
001					Slovakia SSE
004	000	Turkey	002		Slovakia ZSD
005	000	Denmark	033	000	Ukraine
	001	Denmark TR322	035	000	Mexico LV
006	000	Greece Continent	038	000	Wide-Range-60Hz
	001	Greece island	039	000	Ireland EN50438

007	000	Netherland	040	000	Thailand PEA
008	000	Belgium		001	Thailand MEA
009	000	UK G59/G99	042	000	LV-Range-50Hz
	001	UK G83/G98	044	000	South Africa
010	000	China	046	000	Dubai DEWG
	001	China Taiwan		001	Dubai DEWG MV
011	000	France	107	000	Croatia
	001	France FAR Arrete23	108	000	Lithuania
012	000	Poland			

- **Contr On-Off**

Inverter on-off local control.

- **Set Energy**

Set the total power generation. You can modify the total power generation through this option.

- **Set address**

Set the address (when you need to monitor multiple inverters simultaneously). Default 01.

The Address indicates the address used by the inverter to send its data to the monitoring server. Address 01 is used for single inverters; to extend the monitoring to multiple inverters, use progressive communication addresses.

Note: make sure that the address entered is never 00, because this setting would exclude the possibility of communication between the inverter and the Wi-Fi network or RS485 port.

- **Set Input mode**

3PH 3.3K-12K TL-V3 has 2 MPPT circuit, each MPPT circuit can work interdependently, or divided into parallel mode. User can change the setting according to the configuration.

- **Language**

Set the inverter display language.

- **MPPT Scan**

Shadow scanning, when the component is blocked or abnormal, causing multiple power peaks, by enabling this function, the peak point of maximum power can be tracked.



- **Logic interface**

Enable or disable logical interfaces. It is use for below standard Australia (AS4777), Europe General (50549), German (4105).

- **Set Power Ratio.**

Set generation ratio.

- **Autotest Fast**



OK	Start Autotest	Long press the “√” to start
	Testing 59.S1...	
	↓	Wait
	Test 59.S1 OK!	
	↓	Wait
	Testing 59.S2...	
	↓	Wait
	Test 59.S2 OK!	
	↓	Wait
	Testing 27.S1...	
	↓	Wait
	Test 27.S1 OK!	
	↓	Wait
	Testing 27.S2...	
	↓	Wait
	Test 27.S2 OK!	
	↓	Wait
	Testing 81>S1...	
	↓	Wait
	Test 81>S1 OK!	
	↓	Wait
	Testing 81>S2...	
	↓	Wait
	Test 81>S2 OK!	
	↓	Wait
	Testing 81<S1...	
	↓	Wait
	Test 81<S1 OK!	
	↓	Wait
	Testing 81<S2...	
	↓	Wait
	Test 81<S2 OK!	
	↓	Long press the “√”
	Auto Test OK!	
	↓	Short press the “√”
	59.S1 threshold 253V 900ms	
	↓	Short press the “√”
	59.S1: 228V 902ms	
	↓	Short press the “√”
	59.S2 threshold 264.5V 200ms	





↓	Short press the “√”
59.S2: 229V 204ms	
↓	Short press the “√”
27.S1 threshold 195.5V 1500ms	
↓	Short press the “√”
27.S1: 228V 1508ms	
↓	Short press the “√”
27.S2 threshold 34.5V 200ms	
↓	Short press the “√”
27.S2: 227V 205ms	
↓	Short press the “√”
81>.S1 threshold 50.5Hz 100ms	
↓	Short press the “√”
81>.S1 49.9Hz 103ms	
↓	Short press the “√”
81>.S2 threshold 51.5Hz 100ms	
↓	Short press the “√”
81>.S2 49.9Hz 107ms	
↓	Short press the “√”
81<.S1 threshold 49.5Hz 100ms	
↓	Short press the “√”
81<.S1 50.0Hz 105ms	
↓	Short press the “√”
81<.S2 threshold 47.5Hz 100ms	
↓	Short press the “√”
81<.S2 50.1Hz 107ms	

- **Autotest STD**

The test procedure is same as Autotest Fast, but it's much more time consuming.



**(B) Event list**

Event List is used to display the real-time event records, including the total number of events and each specific ID No. and happening time. User can enter Event List interface through main interface to check details of real-time event records, Event will be listed by the happening time, and recent events will be listed in the front. Please refer to below picture. Long press the button and short press the button to turn the page in standard interface, then enter into "2. Event List" interface.

2. Event List	
1. Current event	2. History event
Fault information	001 ID04 06150825 (Display the event sequence number, event ID number, and event occurrence time)

**(C) "SystemInfo" Interface as below**

3.SystemInfo	-----Long press DOWN button
	1.Inverter Type
	2.Serial Number
	3.Soft Version
	4.Hard Version
	5.Country
	6.Modbus Address
	7.Input Mode

The user enters the main menu by long pressing the DOWN button, short press and turns the page to select menu contents, then long press the button to enter "3. SystemInfo". Turning the page down can select the system information to view.

- **Inverter type**

Use the “Up” and “Down” keys in the “System Info” menu to move, and the “OK” key to enter menu “1. Inverter type.” Here you can see the power of the inverter model

- **Serial number**

Use the “Up” and “Down” keys in the “System Info” menu to move, and the “OK” key to enter menu “2. Serial number.” Here you can see the serial number of the inverter.

- **SW version**

Use the “Up” and “Down” keys in the “System Info” menu to move, and the “OK” key to enter menu “3. SW version.” Here you can see the software version.

- **HW version**

Use the “Up” and “Down” keys in the “System Info” menu to move, and the “OK” key to enter menu “4. HW version.” Here you can see the hardware version.

- **Country**

Use the “Up” and “Down” keys in the “System Info” menu to move, and the “OK” key to enter menu “5. Country.” Here you can see the country code that has been set.

- **Modbus Address**

Use the “Up” and “Down” keys in the “System Info” menu to move, and the “OK” key to enter menu “6. Modbus Address.” Here you can see the Modbus Address that has been set.

- **Input**

Use the “Up” and “Down” keys in the “System Info” menu to move, and the “OK” key to enter menu “7. Input.” Here you can see the type of input of the photovoltaic strings.

## **(D) Display time**

Long press the button and short press the button to turn the page in the standard user interface to enter into “4. Display Time”, then long press the button to display the current system time.

## (E) Software Update

User can update software by USB flash disk, Zucchetti Centro Sistemi S.p.a. will provide the new update software called firmware for user if it is necessary, the user needs to copy the upgrade file to the USB flash disk.

### 6.4. Updating Inverter Software

3PH 3.3K-12K TL-V3 inverter offer software upgrade via USB flash drive to maximize inverter performance and avoid inverter operation error caused by software bugs.

**Step 1** : turn off AC circuit breaker and DC switch, remove the communication board cover as below figure. If the RS485 line has been connected, please release the waterproof nut first and make sure the communication line is no longer the force. Then remove the waterproof cover.

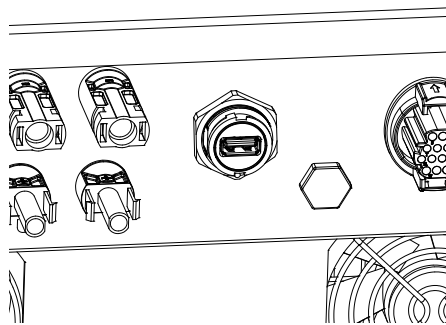

Figure 33 - Remove communication board cover

**Step 2** : Insert USB into computer.

**Step 3** : Zucchetti Centro Sistemi S.p.a. service team will send the software code to user, after user receive the file, please decompressing file and cover the original file in USB flash drive.

**Step 4** : Insert USB flash disk into the USB port of inverter.

**Step 5** : Then turn on DC switch, screen show "recoverable fault" (as AC circuit breaker still open, inverter cannot detect grid power, so it may show "recoverable fault" )

**Step 6** : Long press "DOWN" button to enter the menu, then short press "DOWN" button to find "5. Software Update" in the LCD display, long press "DOWN" button to enter input password interface.

**Step 7** : Input the password, if password is correct, and then begin the update process.

**Step 8** : System update main DSP, slave DSP and ARM in turns. If main DSP update success, the LCD will display "Update DSP1 Success", otherwise display "Update DSP1 Fail"; If slave DSP update success, the LCD will display "Update DSP2 Success", otherwise display "UpdateDSP2 Fail".

**Step 9** : After the update is completed, turn off the DC breaker, wait for the LCD screen extinguish, then recover the communication waterproof and then turn on the DC breaker and AC breaker again, the inverter will enter the running state. User can check the current software version in SystemInfo>>3.SoftVersion.

**Note:** If screen shows "Communication fail" , "Update DSP1 fail" , "Update DSP2 fail" please turn off the DC switch, wait for the LCD screen turn off, then turn on the DC switch again, then Continue to update from step 5.

## 7. Troubleshooting and maintenance

### 7.1. Troubleshooting

This section contains information and procedures on how to troubleshoot any faults and errors that may occur during operation of the 3.3K-12K TL-V1 inverter.

**If you have any problems with the inverter, please follow these steps.**

- Check the warning messages and error codes on the information panel of the inverter. Record them before carrying out any further operation.
- If the inverter does not display any errors, perform the following checks:
  - Is the inverter located in a clean, dry and properly ventilated place?
  - Is the DC switch closed?
  - Are the cables correctly sized and as short as possible?
  - Are the input/output connections and the cables in good condition?
  - Are the configuration settings correct for the type of installation?
  - Are the display panel and flat communication cable correctly connected and not damaged?

Follow the steps below to display the recorded alarms:

Press “Menu/Back” to enter the main menu from the standard interface. Select “Event List” in the menu screen, then press “OK” to access the list of alarms and errors.

#### Information on event list

Error code	Error name	Error description	Possible solution
ID01	GridOVP	The grid voltage is too high.	If the alarm occurs occasionally, the probable cause is that the electric grid is in an abnormal state.  The inverter will automatically return to its normal operating state when the electrical grid is restored to its normal state.
ID02	GridUVP	The grid voltage is too low.	



<b>ID03</b>	GridOFF	The grid frequency is too high.	<p>If the alarm occurs frequently, check whether the grid voltage/frequency is within the correct range. If not, contact technical support. If so, check the AC circuit breaker and the AC wiring of the inverter.</p>
<b>ID04</b>	GridUFP	The grid frequency is too low.	<p>If the voltage/frequency is within the acceptable range and the AC wiring is correct while the alarm occurs repeatedly, contact Technical Support to change the grid overvoltage, undervoltage, over-frequency and under-frequency protection points after obtaining approval from the local grid operator.</p>
<b>ID05</b>	PVUVP	The input voltage is too low.	<p>Check whether too few PV modules have been connected in series in a PV string: therefore, the voltage (<math>V_{mp}</math>) of the photovoltaic string is lower than the minimum operating voltage of the inverter. In this case, adjust the number of photovoltaic modules connected in series to increase the voltage of the PV string, so that it falls within the input voltage range of the inverter.</p>
<b>ID06</b>	Vlvrtlow	LVRT function error	<p>Check the AC grid connections, and if they are correct, contact technical support.</p>
<b>ID07</b>	Vovrthigh	OVRT function error	
<b>ID09</b>	PvOVP	The input voltage is too high.	<p>The inverter automatically returns to its normal operating state after correct adjustment.</p> <p>Check whether too many PV modules have been connected in series in a PV string: therefore, the voltage (<math>V_{oc}</math>) of the photovoltaic string is greater than the minimum operating voltage of the inverter. In this case, decrease the voltage of the PV string by adjusting the number of photovoltaic modules</p>

			mounted in series, making sure that it falls within the input voltage range of the inverter. The inverter automatically returns to its normal operating state after the correct adjustments.
<b>ID10</b>	IpvUnbalance	The input current is not balanced.	Check the configuration of the input mode (parallel mode / independent mode) of the inverter, as indicated in relative section (C) "6. Input Mode" of this user manual; if it is incorrect, change it according to relative section (A).
<b>ID11</b>	PvConfigSetWrong	Incorrect input mode	
<b>ID12</b>	GFCIFault	Faulty automatic differential circuit breaker.	If the error occurs occasionally, the probable cause is that the external circuits have temporary faults. The inverter automatically returns to its normal operating state after the error has been fixed.
<b>ID13</b>	GridFault	Check the voltage and frequency of the grid	
<b>ID14</b>	HwBoostOCP	The input current is too high and has caused the hardware protection to be activated.	Check whether the input current is higher than the maximum input current of the inverters, then check the input wiring; if both are correct, contact Technical Support.
<b>ID15</b>	HwAcOCP	The grid current is too high and has caused the hardware protection to be activated.	ID15-ID24 are internal faults of the inverter; turn off the "DC switch", wait 5 minutes and then turn it back on again. Check that the fault is no longer present. If this is not the case, contact Technical Support.
<b>ID16</b>	AcRmsOCP	The grid current is too high.	
<b>ID17</b>	HwADFaultIGrid	Sampling error of the grid current.	
<b>ID18</b>	HwADFaultDCI	DCI sampling error.	
<b>ID19</b>	HwADFaultVGrid	Sampling error of the grid voltage.	
<b>ID20</b>	GFCIDeviceFault	GFCI sampling error.	
<b>ID21</b>	MChip_Fault	Master chip fault	

<b>ID22</b>	HwAuxPowerFault	Auxiliary voltage error	
<b>ID23</b>	BusVoltZeroFault	Current sampling error.	
<b>ID24</b>	IacRmsUnbalance	The output current is not balanced.	
<b>ID25</b>	BusUVP	The bus voltage is too low.	If the configuration of the PV string is correct (no ID05 fault present), the possible cause is that the solar radiation is too low. The inverter automatically returns to its normal operating state when the solar radiation returns to a normal level.
<b>ID26</b>	BusOVP	The bus voltage is too high.	ID26-ID27 are internal faults of the inverter; turn off the “DC switch”, wait 5 minutes and then turn it back on again. Check that the fault is no longer present. If this is not the case, contact Technical Support.
<b>ID27</b>	VbusUnbalance	The bus voltage is not balanced.	
<b>ID28</b>	DciOCP	The DCI is too high.	<p>Check the configuration of the input mode (parallel mode / independent mode) of the inverter, as indicated in relative section (C) “6. Input Mode” of this user manual. If it is not correct, change it according to relative section (A) “10. Configuration of the Input Mode” of this manual.</p> <p>If the input mode is correct, turn off the “DC switch”, wait 5 minutes and then turn it back on again. Check that the fault is no longer present. If this is not the case, contact Technical Support. If it is not correct, change it according to relative section (A) “10. Configuration of the Input Mode” of this manual.</p>
<b>ID29</b>	SwOCPIstant	The grid current is too high.	Internal faults of the inverter; turn off the “DC switch”, wait 5 minutes and then turn it back on again. Check that the fault is no longer present. If this is not the case, contact Technical Support.
<b>ID30</b>	SwBOCPIstant	The input current is too high.	Check whether the input current is higher than the maximum input current of the inverter, then check the input

			wiring; if both are correct, contact Technical Support.
<b>ID33</b>	Reserved	Reserved	Reserved
<b>ID49</b>	ConsistentFault_VGrid	The grid voltage sampling value between the master DSP and slave DSP is not suitable.	<p>ID49-ID55 are internal faults of the inverter; turn off the “DC switch”, wait 5 minutes and then turn it back on again. Check that the fault is no longer present. If this is not the case, contact Technical Support.</p>
<b>ID50</b>	ConsistentFault_FGrid	The grid frequency sampling value between the master DSP and slave DSP is not suitable.	
<b>ID51</b>	ConsistentFault_DCI	The current sampling value of the automatic differential circuit breaker between the master DSP and the slave DSP is not suitable.	
<b>ID52</b>	ConsistentFault_GFCI	The sampling value of the automatic differential circuit breaker between the master DSP and the slave DSP is not suitable.	
<b>ID53</b>	SpiCommLose	SPI communication between the master DSP and the slave DSP is faulty.	
<b>ID54</b>	SciCommLose	SCI communication between the control board and communication board is faulty.	
<b>ID55</b>	RelayTestFail	Relay fault.	
<b>ID56</b>	PvIsoFault	The insulation resistance is too low.	

<b>ID57</b>	OverTempFault_Inv	The temperature of the inverter is too high	<p>Check that the installation position and the installation method meet the requirements of relative section of this user manual.</p> <p>Check if the ambient temperature in the installation location exceeds the allowed limit. If so, improve the ventilation to reduce the temperature.</p>
<b>ID58</b>	OverTempFault	The temperature of the inverter is too high.	
<b>ID59</b>	OverTempFault_Env	The ambient temperature is too high.	
<b>ID60</b>	Grounding Abnormal	Incorrect grounding	Check that the grounding is correct.
<b>ID61</b>	InvTempDiffFault	The temperature difference between the three R/S/T phases is greater than 10°C	Contact Technical Support
<b>ID65</b>	UnrecoverHwAcOCP	The grid current is too high and has caused an irreparable hardware failure.	<p>ID65-ID70 are internal faults of the inverter; turn off the “DC switch”, wait 5 minutes and then turn it back on again. Check that the fault is no longer present. If this is not the case, contact Technical Support.</p>
<b>ID66</b>	UnrecoverBusOVP	The bus voltage is too high and has caused an irreparable fault.	
<b>ID67</b>	UnrecoverIacRmsUnbalance	The grid current is not balanced and has caused an irreparable fault.	
<b>ID68</b>	UnrecoverIpvUnbalance	The input current is not balanced and has caused an irreparable fault.	
<b>ID69</b>	UnrecoverVbusUnbalance	The bus voltage is not balanced and has caused an irreparable fault.	
<b>ID70</b>	UnrecoverOCPIinstant	The grid current is too high and has caused an irreparable fault.	

<b>ID71</b>	UnrecoverPvConfigSetWrong	Incorrect input mode	Check the configuration of the input mode (parallel mode / independent mode) of the inverter, as indicated in relative section (C) “6. Input Mode” of this user manual. If it is not correct, change it according to relative section (A).
<b>ID72-ID73</b>	Reserved	Reserved	Reserved
<b>ID74</b>	UnrecoverIPVInstant	The input current is too high and has caused an irreparable fault.	ID74-ID77 are internal faults of the inverter; turn off the “DC switch”, wait 5 minutes and then turn it back on again. Check that the fault is no longer present. If this is not the case, contact Technical Support.
<b>ID75</b>	UnrecoverWRITEEEPROM	The E E P R O M cannot be recovered.	
<b>ID76</b>	UnrecoverREADEEPROM	The E E P R O M cannot be recovered.	
<b>ID77</b>	UnrecoverRelayFail	The relay has generated a permanent fault.	
<b>ID78-ID80</b>	Reserved	Reserved	Reserved
<b>ID81</b>	OverTempDerating	The inverter has been derated because the temperature is too high.	Check that the installation position and the installation method meet the requirements of relative section of this user manual. Check if the ambient temperature in the installation location exceeds the allowed limit. If so, improve the ventilation to reduce the temperature.
<b>ID82</b>	OverFreqDerating	The inverter has been derated because the grid current is too high.	The inverter automatically reduces the output power when the frequency of the electrical grid is too high.
<b>ID83</b>	RemoteDerating	The inverter has been derated by the remote control	The inverter registers ID83 in case of remote derating operation. Check the wiring of the remote input and the port of the output control signal on the communication board according to relative section of this user manual.

<b>ID84</b>	RemoteOff	The inverter has shut off the motor via remote control.	The inverter registers ID 84 in case of remote shutdown operation. Check the wiring of the remote input and the port of the output control signal on the communication board, according to relative section of this user manual.
<b>ID85</b>	UnderFrequency Derating	The inverter has been derated because the grid current is too low.	The inverter automatically reduces the output power when the frequency of the electrical grid is too low.
<b>ID89</b>	Reserved	Reserved	Reserved
<b>ID91</b>	Fan1 alarm	Fan1 error	Check the external fans
<b>ID92</b>	Fan2 alarm	Fan2 error	Check the external fan
<b>ID94</b>	The software version is unsuitable	The software between the control board and communication board is unsuitable.	Contact Technical Support to update the software.
<b>ID95</b>	Faulty communication board.	The EEPROM of the communication board is faulty.	ID95-ID96 are internal faults of the inverter; turn off the "DC switch", wait 5 minutes and then turn it back on again. Check that the fault is no longer present. If this is not the case, contact Technical Support.
<b>ID96</b>	Faulty RTC clock chip	The RTC clock chip is faulty.	
<b>ID97</b>	Invalid country	The country is not valid	Check the configuration of the country, as indicated in relative section (C) "5. Country" of this user manual; if it is not correct, change it according to relative section (A) "4. Configuration of country code" of this manual.
<b>ID98</b>	Faulty SD	The SD card is faulty.	Replace the SD card.
<b>ID99</b>	Reserved		Reserved

ID100	Reserved		Reserved
-------	----------	--	----------

## 7.2. Maintenance

Inverters generally do not require daily or routine maintenance. In any case, for proper long-term operation of the inverter, make sure that the heatsink for cooling the inverter has enough space to ensure adequate ventilation and that it is not obstructed by dust or other items.

### Cleaning the inverter

Use an air compressor, a soft dry cloth or soft-bristled brush to clean the inverter. Do not use water, corrosive chemical substances or aggressive detergents to clean the inverter. Disconnect the AC and DC power to the inverter before performing any cleaning operations.

### Cleaning the heatsink

Use an air compressor, a soft dry cloth or soft-bristled brush to clean the heatsink. Do not use water, corrosive chemical substances or aggressive detergents to clean the heatsink. Disconnect the AC and DC power to the inverter before performing any cleaning operations.



## 8. Uninstalling

### 8.1. Uninstallation steps

- Disconnect the inverter from the AC grid.
- Switch off the DC switch.
- Wait 5 minutes.
- Remove the DC connectors.
- Remove the AC terminals.
- Unscrew the fixing bolt of the bracket and remove the inverter from the wall.

### 8.2. Packaging

If possible, pack the product in its original packaging.

### 8.3. Storage

Store the inverter in a dry place where the ambient temperature is between -25 and +60°C.

### 8.4. Disposal

Zucchetti Centro Sistemi S.p.a. is not liable for the disposal of the equipment, or parts thereof, that does not take place according to the regulations and standards in force in the country of installation.



The symbol of the crossed-out wheeled bin indicates that the equipment, at the end of its useful life, must be disposed of separately from household waste.

This product must be handed over to the waste collection point in your local community for recycling.

For more information, please contact the waste collection authority in your country.

Inappropriate waste disposal could have negative effects on the environment and on human health due to potentially hazardous substances.

With your cooperation in the correct disposal of this product, you contribute to the reuse, recycling and recovery of the product, and to the protection of our environment.

## 9. Technical specifications

TECHNICAL DATA	3PH 3.3KTL-V3	3PH 4.4KTL-V3	3PH 5.5KTL-V3	3PH 6.6KTL-V3	3PH 8.8KTL-V3	3PH 11KTL-V3	3PH 12KTL-V3
<b>DC Input data</b>							
Typical DC power*	3960 W	5280 W	6600 W	7920 W	10560 W	13200 W	14400 W
Maximum DC power per MPPT	3550W(320V-850V)	4500W(410V-850V)	5700W(520V-850V)	6250W(570V-850V)	6200W(560V-850V)		6850W(620V-850V)
No. of independent MPPTs / No. of strings per MPPT	2/1						2/(2/1)
Maximum DC input voltage	1100V						
Start-up voltage	160V						
Nominal DC input voltage	650V						
MPPT DC voltage range	140V-1000V						
DC voltage range at full load	160V-850V	190V-850V	240V-850V	290V-850V	380V-850V	420V-850V	420V-850V
Maximum input current per MPPT	13A/13A						26A/13A
Maximum absolute current per MPPT	18A/18A						36A/18A
<b>AC Output data</b>							
Rated AC power	3000 W	4000 W	5000 W	6000 W	8000 W	10000 W	12000 W
Maximum AC power	3300VA	4400VA	5500VA	6600VA	8800VA	11000VA	13200VA
Maximum AC current per phase	4.8A	6.4A	8.0A	9.6A	12.8A	15.9A	17.4A
Connection type/ Rated grid voltage	Three-phase 3PH/N/PE 220V/230V/240V (PH-N); 380V/400V/415V (PH-PH) or Three-phase 3PH/PE 380V/400V/415V (PH-PH)						
Grid voltage range	184V~276V (PH-N); 310V~480V (PH-PH) (according to the local grid standards)						
Rated grid frequency	50Hz/60Hz						
Grid frequency range	45Hz~55Hz / 54Hz~66Hz (according to the local grid standards)						
Total harmonic distortion	<3%						
Power factor	1 (Programmable +/-0.8)						
Active power adjustment range (settable)	0~100%						
Grid feed-in limit	Feed-in adjustable from zero to nominal power value**						
<b>Efficiency</b>							
Maximum efficiency	98.4%						98.5%
Weighted efficiency (EURO)	97.5%						98%
MPPT efficiency	>99.9%						
Consumption at night	<1W						
<b>Protections</b>							
Internal interface protection	Yes						No
Safety protections	Anti-islanding, RCMU, Ground Fault Monitoring						
Reverse polarity protection DC	Yes						
DC circuit breaker	Integrated						
Overheating protection	Yes						
Overvoltage category/Protection class	Overvoltage Category III / Protection class I						
Integrated dischargers	AC/DC MOV: Type 2 Standard						
<b>Standard</b>							
EMC	EN 61000-6-1/2/3/4,						
Safety standard	IEC 62116, IEC 61727, IEC 61683, IEC 60068-1/2/14/30, IEC 62109-1/2						
Grid connection standard	Connection certificates and standards available on <a href="http://www.zcsazzurro.com">www.zcsazzurro.com</a>						
<b>Communication</b>							
Communication interfaces	Wi-Fi/4G/Ethernet (optional), RS485 (proprietary protocol), USB						
<b>General data</b>							
Allowable ambient temperature range	-30°C...+60°C (power limit above 45°C)						
Topology	Transformerless						
Environmental protection class	IP65						
Allowable relative humidity range	0%...95% non-condensing						
Maximum operating altitude	4000m						
Noise level	< 40dB @ 1mt						
Weight	17Kg				18Kg		
Cooling	Natural convection						
Dimensions (H x L x D)	425mm x 513mm x 169mm						
Display	LCD						
Warranty	10 years						

\* The typical DC power does not represent a maximum applicable power limit. The online configurator available at [www.zcsazzurro.com](http://www.zcsazzurro.com) will provide any applicable configurations.

\*\* Possible by using a specific meter

## 10. Monitoring systems

### 10.1. External Wi-Fi adapter

#### 10.1.1. Installation

Unlike the internal Wi-Fi card, the external adapter must be installed for all compatible inverters. However, the procedure is quicker and easier as there is no need to open the front cover of the inverter.

In order to monitor the inverter, the RS485 communication address must be set to 01 directly from the display.

#### Installation tools:

- Cross screwdriver
  - External Wi-Fi adapter
- 1) Switch off the inverter following the procedure described in this manual.
  - 2) Remove the cover for accessing the Wi-Fi connector on the bottom of the inverter by unscrewing the two cross-head screws (a), or by unscrewing the cover (b), as shown in the figure.



Figure 34 – Port for external Wi-Fi adapter

- 3) Connect the Wi-Fi adapter to the appropriate port, making sure to follow the direction of the connection and ensure correct contact between the two parts.

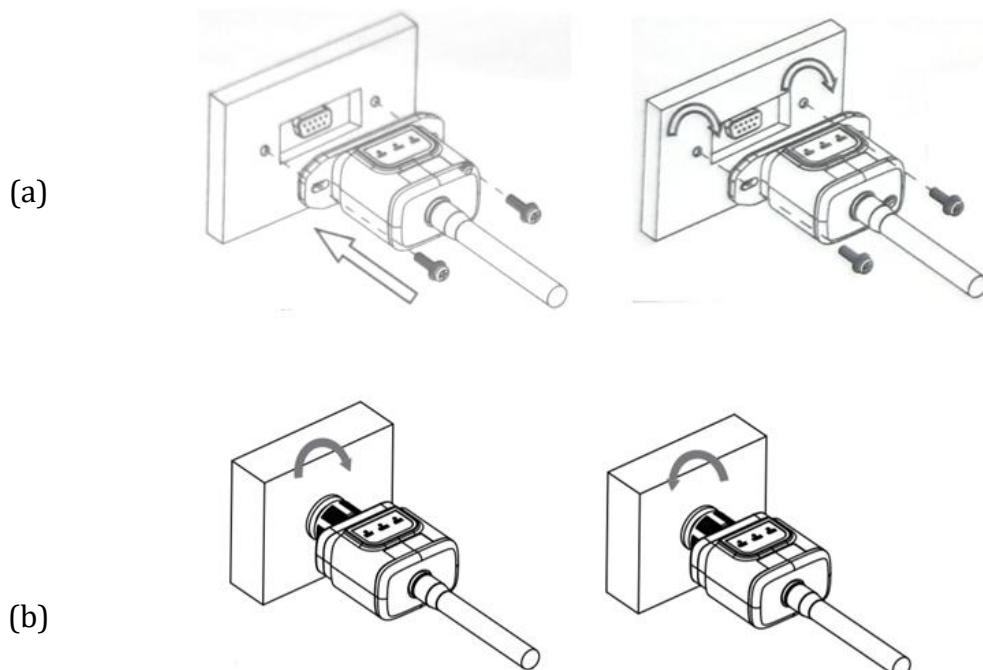

Figure 35 – Inserting and securing the external Wi-Fi adapter

4) Switch on the inverter by following the procedure described in the manual.

### 10.1.2. Configuration

Configuration of the Wi-Fi adapter requires the presence of a Wi-Fi network near the inverter in order to achieve stable transmission of data from the inverter adapter to the Wi-Fi modem.

#### Tools required for configuration:

- Smartphone, PC or tablet

Go to front of the inverter and search for the Wi-Fi network using a smartphone, PC or tablet, making sure that the signal from the home Wi-Fi network reaches the place where the inverter is installed.

If the Wi-Fi signal is present at the location where the inverter is installed, the configuration procedure can begin.

If the Wi-Fi signal does not reach the inverter, a system must be installed to amplify the signal and bring it to the installation location.

- 1) Activate the search for the Wi-Fi networks on your telephone or PC so that all the networks visible by your device are displayed.



Figure 36 - Search for Wi-Fi networks on iOS smartphone (left) and Android smartphone (right)

Note: Disconnect from any Wi-Fi networks to which you are connected by removing automatic access.



Figure 37 - Disabling automatic reconnection to a network

- 2) Connect to a Wi-Fi network generated by the inverter's Wi-Fi adapter (i.e. AP\_\*\*\*\*\*, where \*\*\*\*\* indicates the serial number of the Wi-Fi adapter shown on the label of the device), which operates as an access point.

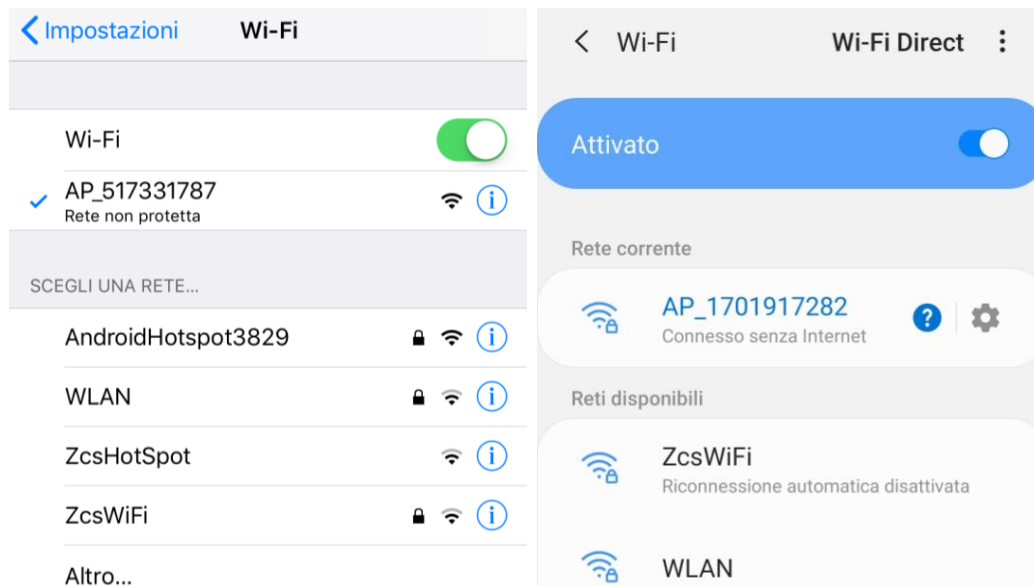

Figure 38 - Connection to Access Point for Wi-Fi adapter on iOS smartphone (left) and Android smartphone (right)

- 3) If you are using a second-generation Wi-Fi adapter, you will be prompted for a password to connect to the inverter's Wi-Fi network. Use the password found on the box or on the Wi-Fi adapter.



Figure 39 – Password of external Wi-Fi adapter

Note: To ensure that the adapter is connected to the PC or smartphone during the configuration procedure, enable automatic reconnection of the AP\_\*\*\*\*\* network.

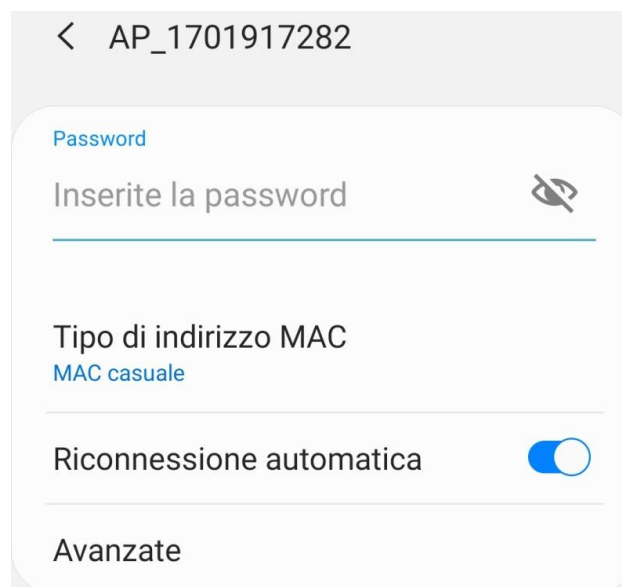

Figure 40 – Password entry prompt

Note: the Access Point is not able to provide internet access; confirm to maintain the Wi-Fi connection, even if the internet is not available

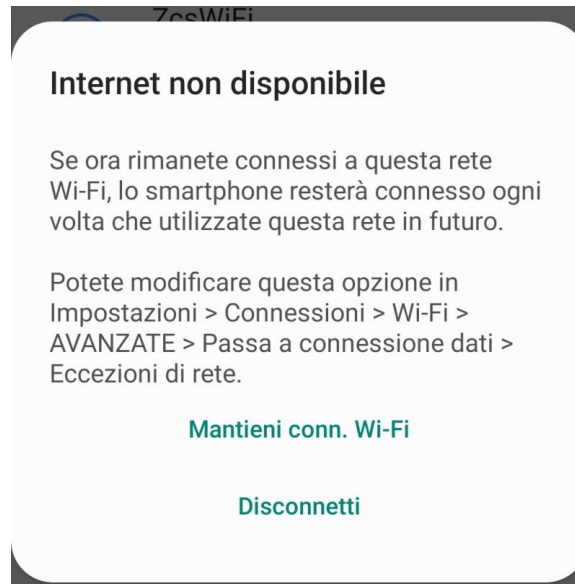

Figure 41 – Screen indicating that the Internet cannot be accessed

- 4) Open a browser (Google Chrome, Safari, Firefox) and enter the IP address 10.10.100.254 in the address bar at the top of the screen.  
In the box that appears, enter “admin” as both the Username and Password.



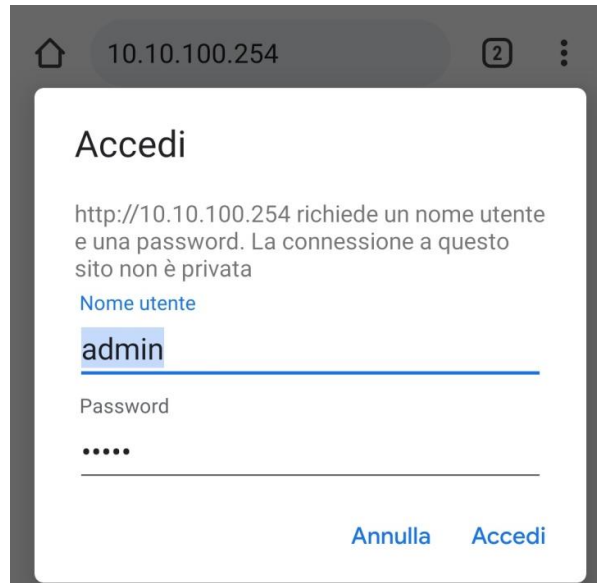

Figure 42 – Screen for accessing the web server to configure the Wi-Fi adapter

- 5) The status screen will open, showing the logger information such as the serial number and firmware version.

Check that the Inverter Information fields are filled in with the inverter information.

The language of the page can be changed using the command in the top right-hand corner.

中文 | English

<b>Status</b> Wizard Quick Set Advanced Upgrade Restart Reset	<div style="border: 2px solid red; padding: 5px; margin-bottom: 10px;"> <b>- Inverter information</b>          Inverter serial number: ZH1ES160J3E488          Firmware version (main): V210          Firmware version (slave): --       </div> <table style="width: 100%; border-collapse: collapse;"> <tr><td>Inverter model</td><td>ZH1ES160</td></tr> <tr><td>Rated power</td><td>-- W</td></tr> <tr><td><b>Current power</b></td><td><b>--- W</b></td></tr> <tr><td>Yield today</td><td>11.2 kWh</td></tr> <tr><td><b>Total yield</b></td><td><b>9696.0 kWh</b></td></tr> <tr><td><b>Alerts</b></td><td><b>F12F14</b></td></tr> <tr><td>Last updated</td><td>0</td></tr> </table> <b>- Device information</b> <table style="width: 100%; border-collapse: collapse;"> <tr><td>Device serial number</td><td>1701917282</td></tr> <tr><td>Firmware version</td><td>LSW3_14_FFFF_1.0.00</td></tr> <tr><td>Wireless AP mode</td><td><b>Enable</b></td></tr> <tr><td>  SSID</td><td>AP_1701917282</td></tr> <tr><td>  IP address</td><td>10.10.100.254</td></tr> <tr><td>  MAC address</td><td>98:d8:63:54:0a:87</td></tr> <tr><td>Wireless STA mode</td><td><b>Enable</b></td></tr> <tr><td>  Router SSID</td><td>AP_SOLAR_PORTAL_M2M_20120615</td></tr> <tr><td>  Signal Quality</td><td>0%</td></tr> <tr><td>  IP address</td><td>0.0.0.0</td></tr> <tr><td>  MAC address</td><td>98:d8:63:54:0a:86</td></tr> </table> <b>- Remote server information</b> <table style="width: 100%; border-collapse: collapse;"> <tr><td>Remote server A</td><td>Not connected</td></tr> <tr><td>Remote server B</td><td>Not connected</td></tr> </table>	Inverter model	ZH1ES160	Rated power	-- W	<b>Current power</b>	<b>--- W</b>	Yield today	11.2 kWh	<b>Total yield</b>	<b>9696.0 kWh</b>	<b>Alerts</b>	<b>F12F14</b>	Last updated	0	Device serial number	1701917282	Firmware version	LSW3_14_FFFF_1.0.00	Wireless AP mode	<b>Enable</b>	SSID	AP_1701917282	IP address	10.10.100.254	MAC address	98:d8:63:54:0a:87	Wireless STA mode	<b>Enable</b>	Router SSID	AP_SOLAR_PORTAL_M2M_20120615	Signal Quality	0%	IP address	0.0.0.0	MAC address	98:d8:63:54:0a:86	Remote server A	Not connected	Remote server B	Not connected	<b>Help</b> <p>The device can be used as a wireless access point (AP mode) to facilitate users to configure the device, or it can also be used as a wireless information terminal (STA mode) to connect the remote server via wireless router.</p> <p><b>Status of remote server</b>      ◆Not connected: Connection to server failed last time.      If under such status, please check the issues as follows:      (1) check the device information to see whether IP address is obtained or not;      (2) check if the router is connected to internet or not;      (3) check if a firewall is set on the router or not;</p> <p>◆Connected: Connection to server successful last time;</p> <p>◆Unknown: No connection to server. Please check again in 5 minutes.</p>
Inverter model	ZH1ES160																																									
Rated power	-- W																																									
<b>Current power</b>	<b>--- W</b>																																									
Yield today	11.2 kWh																																									
<b>Total yield</b>	<b>9696.0 kWh</b>																																									
<b>Alerts</b>	<b>F12F14</b>																																									
Last updated	0																																									
Device serial number	1701917282																																									
Firmware version	LSW3_14_FFFF_1.0.00																																									
Wireless AP mode	<b>Enable</b>																																									
SSID	AP_1701917282																																									
IP address	10.10.100.254																																									
MAC address	98:d8:63:54:0a:87																																									
Wireless STA mode	<b>Enable</b>																																									
Router SSID	AP_SOLAR_PORTAL_M2M_20120615																																									
Signal Quality	0%																																									
IP address	0.0.0.0																																									
MAC address	98:d8:63:54:0a:86																																									
Remote server A	Not connected																																									
Remote server B	Not connected																																									

Figure 43 – Status screen

- 6) Click on the Wizard setup button in the left-hand column.
- 7) In the new screen that opens, select the Wi-Fi network to which you want to connect the Wi-Fi adapter, making sure that the Received Signal Strength Indicator (RSSI) is greater than 30%. If the network is not visible, press the Refresh button.  
 Note: check that the signal strength is greater than 30%, if not, bring the router closer or install a repeater or signal amplifier.  
 Click Next.

Please select your current wireless network:

Site Survey

SSID	BSSID	RSSI	Channel
<input checked="" type="radio"/> iPhone di Giacomo	EE:25:EF:6C:31:18	100	6
<input type="radio"/> ZcsWiFi	FE:EC:DA:1D:C3:9	86	1
<input type="radio"/> ZcsHotSpot	FC:EC:DA:1D:C3:9	86	1
<input type="radio"/> WLAN	E:EC:DA:1D:C3:9	86	1
<input type="radio"/> ZcsHotSpot	FC:EC:DA:1D:C8:A3	57	11
<input type="radio"/> WLAN	E:EC:DA:1D:C8:A3	57	11
<input type="radio"/> ZcsWiFi	FE:EC:DA:1D:C8:A3	54	11
<input type="radio"/> WLAN	E:EC:DA:1D:C8:8B	45	1
<input type="radio"/> ZcsWiFi	FE:EC:DA:1D:C8:8B	37	1
<input type="radio"/> ZcsHotSpot	FC:EC:DA:1D:C8:8B	35	1

★Note: When RSSI of the selected WiFi network is lower than 15%, the connection may be unstable, please select other available network or shorten the distance between the device and router.

Refresh

Add wireless network manually:

Network name (SSID)  
(Note: case sensitive)

Encryption method

Encryption algorithm

Next



Figure 44 – Screen for selecting the available wireless network (1)

- Enter the password of the Wi-Fi network (Wi-Fi modem), clicking on Show Password to make sure it is correct; the password should not contain special characters (&, #, %) and spaces.  
Note: During this step, the system is not able to ensure that the password entered is the one actually requested by the modem, therefore please make sure you enter the correct password.  
Also check that the box below is set to Enable.  
Then click “Next” and wait a few seconds for verification.

Please fill in the following information:

Password (8-64 bytes)  
(Note: case sensitive)   
 Show Password

Obtain an IP address  
automatically

IP address

Subnet mask

Gateway address

DNS server address

1 2 3 4

Figure 45 – Screen for entering the password of the wireless network (2)

9) Click “Next” again without ticking any of the options relating to the system security.

### Enhance Security

You can enhance your system security by choosing the following methods

- Hide AP
- Change the encryption mode for AP
- Change the user name and password for Web server

1 2 3 4

Figure 46 - Screen for setting the security options (3)

10) Click “OK”.

**Setting complete!**

Click OK, the settings will take effect and the system will restart immediately.

If you leave this interface without clicking OK, the settings will be ineffective.



**Figure 47 - Final configuration screen (4)**

- 11) At this point, if the configuration of the adapter is successful, the last configuration screen will appear, and the telephone or PC will unpair from the inverter’s Wi-Fi network.
- 12) Manually close the web page with the Close key on the PC por remove it from the background of the telephone.

**Setting complete! Please close this page manually!**

Please login our management portal to monitor and manage your PV system.(Please register an account if you do not have one.)

To re-login the configuration interface, please make sure that your computer or smart phone

Web Ver:1.0.24

Figure 48 - Successful configuration screen

### 10.1.3. Verification

Wait two minutes after configuring the adapter and then go back to the Wi-Fi network selection screen to verify that the AP\_\*\*\*\*\* network is no longer present. The absence of the Wi-Fi network in the list will confirm the successful configuration of the Wi-Fi adapter.



Figure 49 – Wi-Fi network search on Smartphone (iOS and Android); Access point of the Wi-Fi adapter is no longer visible

If the Wi-Fi network is still present in the list, connect to it again and enter the status page. Check the following information:

- a. Wireless STA mode
  - i. Router SSID > Router name
  - ii. Signal Quality > other than 0%
  - iii. IP address > other than 0.0.0.0
- b. Remote server information
  - i. Remote server A > Connected

Wireless STA mode		Enable
Router SSID	iPhone di Giacomo	
Signal Quality	0%	
IP address	0.0.0.0	
MAC address	98:d8:63:54:0a:86	
<b>- Remote server information</b>		
Remote server A	Not connected	

Figure 50 – Status screen

### Status of LEDs present on the adapter

- 1) Initial status:
  - NET (left LED ): off
  - COM (central LED): steady on
  - READY (right LED): flashing on



Figure 51 - Initial status of LEDs

- 2) Final status:
- NET (left LED): steady on
  - COM (central LED): steady on
  - READY (right LED): flashing on



Figure 52 - Final status of LEDs

If the NET LED does not light up or if the Remote Server A option in the Status page still shows “Not Connected”, the configuration was not successful, i.e. the wrong router password was entered or the device was disconnected during connection.



It is necessary to reset the adapter:

- Press the Reset button for 10 seconds and release
- After a few seconds, the LEDs will turn off and READY will start to flash quickly
- The adapter has now returned to its initial state. At this point, the configuration procedure can be repeated again.

The adapter can only be reset when the inverter is switched on.



Figure 53 – Reset button on the Wi-Fi adapter

## 10.1.4. Troubleshooting

### Status of LEDs present on the adapter

#### 1) Irregular communication with inverter

- NET (left LED): steady on
- COM (central LED ): off
- READY (right LED): flashing on



Figure 54 - Irregular communication status between inverter and Wi-Fi

- Check the Modbus address set on the inverter:  
Enter the main menu with the ESC key (first key on the left), go to System Info and press ENTER to enter the submenu. Scroll down to the Modbus address parameter and make sure it is set to 01 (and in any case, other than 00).

If the value is not 01, go to “Settings” (basic settings for hybrid inverters) and enter the Modbus Address menu where the 01 value can be set.

- Check that the Wi-Fi adapter is correctly and securely connected to the inverter, making sure to tighten the two cross-head screws provided.
- Check that the Wi-Fi symbol is present in the top right-hand corner of the inverter's display (steady or flashing).



Figure 55 – Icons on the display of LITE single-phase inverters (left) and three-phase or hybrid inverters (right)

- Restart the adapter:
  - Press the reset button for 5 seconds and release
  - After a few seconds, the LEDs will turn off and will start to flash quickly
  - The adapter will now be reset without having lost the configuration with the router

## 2) Irregular communication with remote server

- NET (left LED ): off
- COM (central LED): on
- READY (right LED): flashing on



Figure 56 - Irregular communication status between Wi-Fi and remote server

- Check that the configuration procedure has been carried out correctly and that the correct network password has been entered.
- When searching for the Wi-Fi network using a smartphone or PC, make sure that the Wi-Fi signal is strong enough (a minimum RSSI signal strength of 30% is required during configuration). If necessary, increase it by using a network extender or a router dedicated to inverter monitoring.
- Check that the router has access to the network and that the connection is stable; check that a PC or smartphone can access the Internet
- Check that port 80 of the router is open and enabled to send data
- Reset the adapter as described in the previous section

If, at the end of the previous checks and subsequent configuration, Remote server A is still “Not Connected” or the NET LED is off, there may be a transmission problem at the home network level and, more specifically, that data between the router and server is not being transmitted correctly. In this case, it is advisable to carry out checks at the router level in order to ensure that there are no obstructions on the output of data packets to our server.

To make sure that the problem lies in the home router and to exclude problems with the Wi-Fi adapter, configure the adapter using the Wi-Fi hotspot function on your smartphone as a reference wireless network.

- **Using an Android mobile phone as a modem**

- Check that the 3G/LTE connection is active on your smartphone. Go to the Settings menu of the operating system (the gear icon on the screen with a list of all the apps installed on the phone), select "Other" from the Wireless and networks menu and make sure that the Network type is set to 3G/4G/5G.
- In the Android settings menu, go to Wireless & networks > Other. Select Mobile Hotspot/Tethering, and then enable the Wi-Fi mobile hotspot option; wait a few seconds for the wireless network to be created. To change the name of the wireless network (SSID) or your password, select Configure Wi-Fi hotspot.

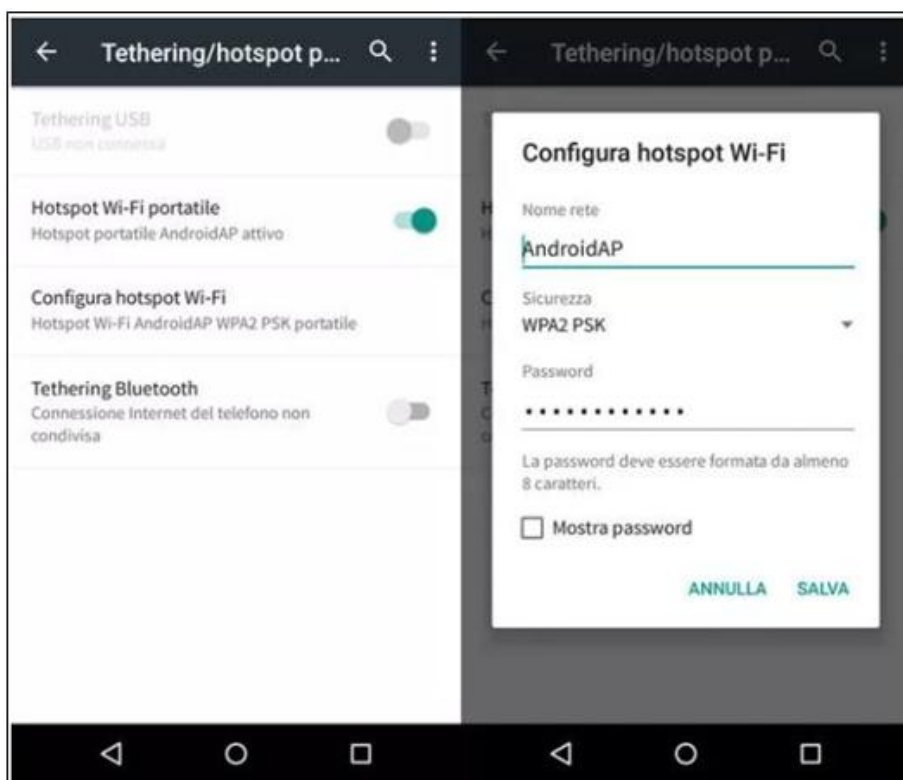

Figure 57 – Configuration of an Android smartphone as a hotspot router

- **Using an iPhone as a modem**

- In order to share the iPhone connection, verify that the 3G/LTE network is active by going to Settings > Mobile Phone, and making sure that the "Voice and data" option is set to 5G, 4G or 3G. To enter the iOS settings menu, click the grey gear icon on the home screen of your phone.
- Go to the Settings menu > Personal Hotspot and turn on the Personal Hotspot option. The hotspot is now enabled. To change the password of the Wi-Fi network, select Wi-Fi password from the personal hotspot menu.

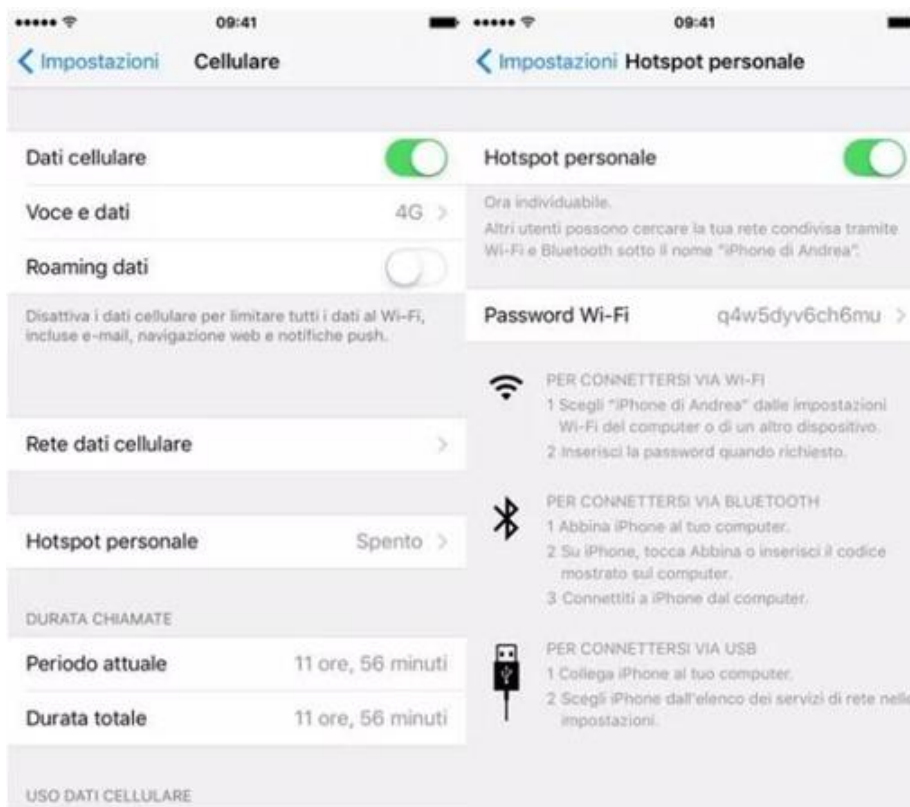

Figure 58 - Configuration of an iOS smartphone as a hotspot router

At this point, it is necessary to re-configure the Wi-Fi adapter using a PC or smartphone other than the one used as a modem.

During this procedure, when asked to select the Wi-Fi network, choose the one activated by the smartphone and then enter the password associated with it (which can be changed from the personal hotspot settings). If at the end of configuration, “Connected” appears next to “Remote Server A”, then the problem is with the home router.

It is therefore advisable to check the brand and model of the home router you are trying to connect to the Wi-Fi adapter; some router brands may have closed communication ports. In this case, contact the customer service of the router’s manufacturer and ask them to open port 80 (direct from the network to external users).

## 10.2. Ethernet adapter

### 10.2.1. Installation

Installation must be carried out for all inverters compatible with the adapter. However, the procedure is quicker and easier as there is no need to open the front cover of the inverter. Proper operation of the device requires the presence of a modem correctly connected to the network and in operation in order to achieve stable data transmission from the inverter to the server.

In order to monitor the inverter, the RS485 communication address must be set to 01 directly from the display.

#### Installation tools:

- Cross screwdriver
- Ethernet adapter
- Shielded network (Cat. 5 or Cat. 6) crimped with RJ45 connectors

- 1) Switch off the inverter following the procedure described in this manual.
- 2) Remove the cover for accessing the Wi-Fi/Eth connector on the bottom of the inverter by unscrewing the two cross-head screws (a), or by unscrewing the cover (b), depending on the inverter model, as shown in the figure.



Figure 59 – Port of the Ethernet adapter

- 3) Remove the ring nut and the waterproof cable gland from the adapter to allow the network cable to pass through; then insert the network cable network into the appropriate port on the inside of the adapter and tighten the ring nut and cable gland to ensure a stable connection.

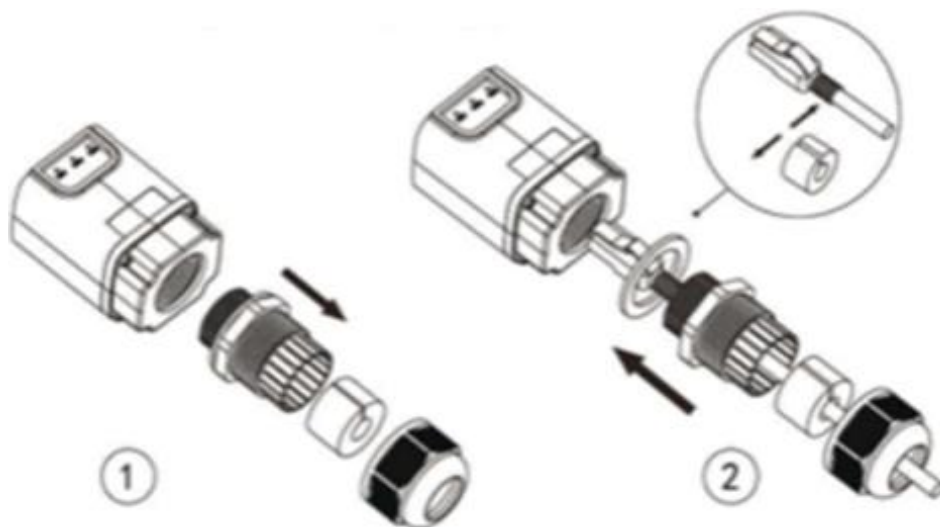

Figure 60 - Inserting the network cable inside the device

- 4) Connect the Ethernet adapter to the appropriate port, making sure to follow the direction of the connection and ensure correct contact between the two parts.

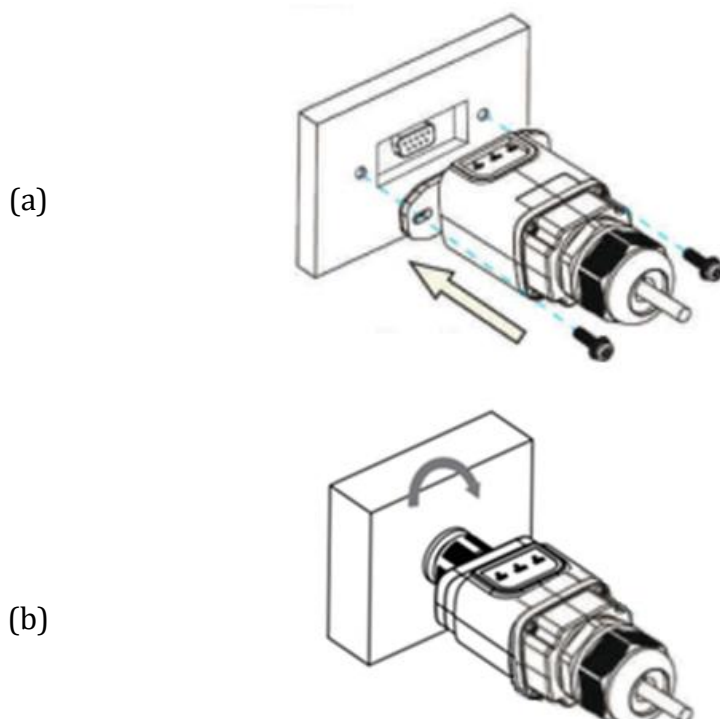

Figure 61 - Inserting and securing the ethernet adapter

- 5) Connect the other end of the network cable to the ETH output (or equivalent) of the modem or a suitable data transmission device.

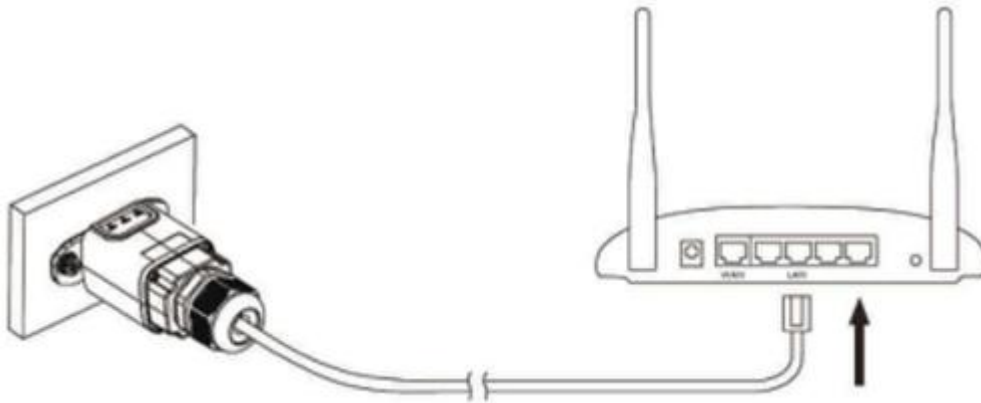

Figure 62 – Connecting the network cable to the modem

- 6) Switch on the inverter by following the procedure described in the manual.
- 7) Unlike Wi-Fi cards, the Ethernet adapter does not need to be configured and starts transmitting data shortly after the inverter is switched on.

### 10.2.2. Verification

Wait two minutes after installing the adapter, and check the status of the LEDs on the device.

#### Status of LEDs present on the adapter

- 1) Initial status:
- NET (left LED ): off
  - COM (central LED): steady on
  - SER (right LED): flashing on





Figure 63 - Initial status of LEDs

- 2) Final status:
- NET (left LED): steady on
  - COM (central LED): steady on
  - SER (right LED): flashing on



Figure 64 - Final status of LEDs



### 10.2.3. Troubleshooting

#### Status of LEDs present on the adapter

- 1) Irregular communication with inverter
  - NET (left LED): steady on
  - COM (central LED ): off
  - SER (right LED): flashing on



Figure 65 - Irregular communication status between the inverter and adapter

- Check the Modbus address set on the inverter:  
Enter the main menu with the ESC key (first key on the left), go to System Info and press ENTER to enter the submenu. Scroll down to the Modbus address parameter and make sure it is set to 01 (and in any case, other than 00).  
If the value is not 01, go to “Settings” (basic settings for hybrid inverters) and enter the Modbus Address menu where the 01 value can be set.
  - Check that the Ethernet adapter is correctly and securely connected to the inverter, making sure to tighten the two cross-head screws provided. Check that the network cable is correctly inserted into the device and modem, and that the RJ45 connector is correctly crimped.
- 2) Irregular communication with remote server
    - NET (left LED ): off
    - COM (central LED): on
    - SER (right LED): flashing on



Figure 66 - Irregular communication status between the adapter and remote server

- Check that the router has access to the network and that the connection is stable; check that a PC can access the Internet

Check that port 80 of the router is open and enabled to send data.

It is advisable to check the brand and model of the home router you are trying to connect to the Ethernet adapter; some router brands may have closed communication ports. In this case, contact the customer service of the router's manufacturer and ask them to open port 80 (direct from the network to external users).

### 10.3. 4G adapter

The ZCS 4G adapters are sold with a virtual SIM integrated into the device with data traffic fee included for 10 years, which is adequate for the proper transmission of data to monitor the inverter.

In order to monitor the inverter, the RS485 communication address must be set to 01 directly from the display.

#### 10.3.1. Installation

Installation must be carried out for all inverters compatible with the adapter. However, the procedure is quicker and easier as there is no need to open the front cover of the inverter.

### Installation tools:

- Cross screwdriver
- 4G adapter

- 1) Switch off the inverter following the procedure described in this manual.
- 2) Remove the cover for accessing the Wi-Fi/ GPRS connector on the bottom of the inverter by unscrewing the two cross-head screws (a), or by unscrewing the cover (b), depending on the inverter model, as shown in the figure.



Figure 67 – Port of the 4G adapter

- 3) Insert the 4G adapter into the appropriate port, making sure to follow the direction of the connection and ensure correct contact between the two parts. Secure the 4G adapter by tightening the two screws inside the package.

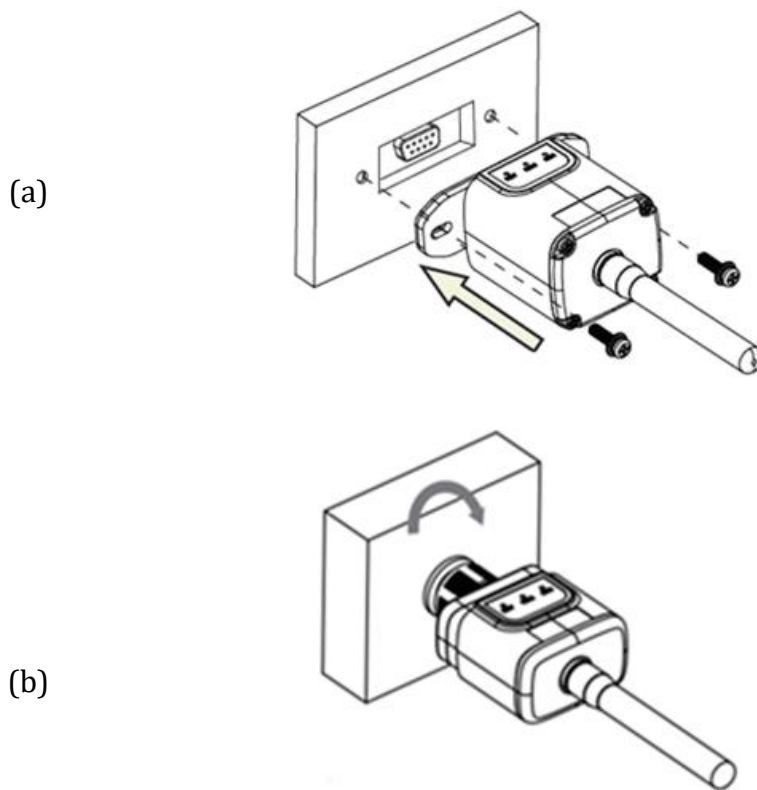

Figure 68 – Inserting and securing the 4G adapter

- 4) Switch on the inverter by following the procedure described in the manual.
- 5) Unlike Wi-Fi cards, the 4G adapter does not need to be configured and starts transmitting data shortly after the inverter is switched on.

### 10.3.2. Verification

After installing the adapter, within the next 3 minutes check the status of the LEDs on the device to ensure that the device is configured correctly.

#### Status of LEDs present on the adapter

1) Initial status:

- NET (left LED ): off
- COM (central LED): flashing on
- SER (right LED): flashing on



Figure 69 - Initial status of LEDs

2) Registration:

- NET (left LED): flashes rapidly for about 50 seconds; the registration process takes about 30 seconds
- COM (central LED): flashes rapidly 3 times after 50 seconds

3) Final status (approx. 150 seconds after the inverter has started):

- NET (left LED): flashing on (off and on at equal intervals)
- COM (central LED): steady on
- SER (right LED): steady on



Figure 70 - Final status of LEDs

### Status of LEDs present on the adapter

#### 1) Irregular communication with inverter

- NET (left LED): on
- COM (central LED ): off
- SER (right LED): on



Figure 71 - Irregular communication status between inverter and adapter

- Check the Modbus address set on the inverter:  
Enter the main menu with the ESC key (first key on the left), go to System Info and press ENTER to enter the submenu. Scroll down to the Modbus address parameter and make sure it is set to 01 (and in any case, other than 00).

If the value is not 01, go to “Settings” (basic settings for hybrid inverters) and enter the Modbus Address menu where the 01 value can be set.

- Check that the 4G adapter is correctly and securely connected to the inverter, making sure to tighten the two cross-head screws provided.

2) Irregular communication with remote server:

- NET (left LED): flashing on
- COM (central LED): on
- SER (right LED): flashing on



Figure 72 - Irregular communication status between the adapter and remote server

- Check that the 4G signal is present in the installation location (the adapter uses the Vodafone network for 4G transmission; if this network is not present or the signal is weak, the SIM will use a different network or will limit the data transmission speed). Ensure that the installation location is suitable for 4G signal transmission and that there are no obstacles that could affect data transmission.
- Check the status of the 4G adapter and that there are no external signs of wear or damage.



## 10.4. Datalogger

### 10.4.1. Preliminary notes on how to configure the datalogger

The AzzurroZCS inverters can be monitored via a datalogger connected to a Wi-Fi network present at the place of installation or via an ethernet cable connected to a modem.

The inverters are connected in a daisy chain to the datalogger via a RS485 serial line.

- Datalogger up to 4 inverters (code ZSM-DATALOG-04): allows to monitor up to 4 inverters. It can be connected to the network via an Ethernet or Wi-Fi network.
- Datalogger up to 10 inverters (code ZSM-DATALOG-10): allows to monitor up to 10 inverters. It can be connected to the network via an Ethernet or Wi-Fi network.



Figure 73 – Diagram for connecting the ZSM-DATALOG-04 / ZSM-DATALOG-10 datalogger

- Datalogger up to 31 inverters (code ZSM-RMS001/M200): allows to monitor up to 31 inverters or a system with a maximum installed power of 200kW. It can be connected to the network via an Ethernet cable.
- Datalogger up to 31 inverters (code ZSM-RMS001/M1000): allows to monitor a maximum of 31 inverters or a system with a maximum installed power of 1000kW. It can be connected to the network via an Ethernet cable.



Figure 74 – Diagram showing the operation of the ZSM-RMS001/M200 / ZSM-RMS001/M1000 datalogger

All these devices carry out the same function, i.e. they transmit data from the inverters to a web server to allow remote monitoring of the system either through the “Azzurro Monitoring” app or through the [“www.zcsazzurroportal.com”](http://www.zcsazzurroportal.com) website.

All the Azzurro ZCS inverters can be monitored using the datalogger; different models or families of inverters can also be monitored.

## 10.4.2. Electrical connections and configuration

All the Azzurro ZCS inverters have at least one RS485 connection point.

The connections can be made via the green terminal block or via the RJ45 plug inside the inverter.

Use positive and negative conductors. There is no need to use a conductor for the GND. This applies to both the terminal block and the plug.

The serial line can be created using a Cat. 5 or Cat. 6 network cable, or a classic RS485 2x0.5mm<sup>2</sup> cable.

- 1) In the case of three-phase inverters, a suitably crimped network cable with a RJ45 connector can also be used:
  - a. Place the blue cable in position 4 of the RJ45 connector and the white-blue cable in position 5 of the RJ45 connector, as shown in the figure below.
  - b. Insert the connector into the 485-OUT terminal.
  - c. If there is more than one three-phase inverter, insert another connector in the 485-IN terminal to connect to the 485-OUT input of the next inverter.



RJ 45	Colore	Monofase	Trifase
4	Blu	TX +	485 A
5	Bianco-Blu	TX -	485 B

Figure 75 - Pin out for connecting the RJ45 connector

- 2) Daisy chain
  - a. Insert the blue cable into input A1 and the white-blue cable into input B1.
  - b. If there is more than one three-phase inverter, insert a blue cable into input A2 and a white-blue cable into input B2 and connect them to the respective A1 and B1 inputs of the next inverter.

Some inverters have both an RS485 terminal block and RJ45 plugs. This is shown in detail in the figure below.

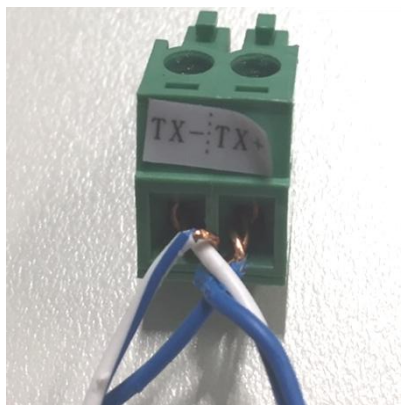

Figure 76 - Tightening the network cable to the RS485 terminal block

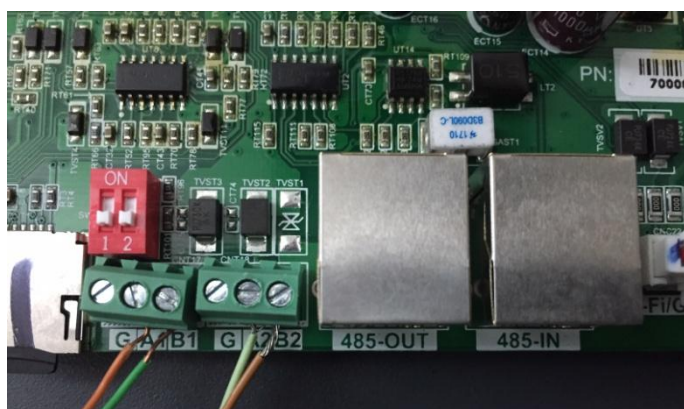

Figure 77 - Connecting the serial line via the RS485 terminal block and via the RJ45 plug

For the 3PH HYD5000-HYD20000-ZSS three-phase hybrid inverter, use only one positive and one negative of those shown in the figure below.

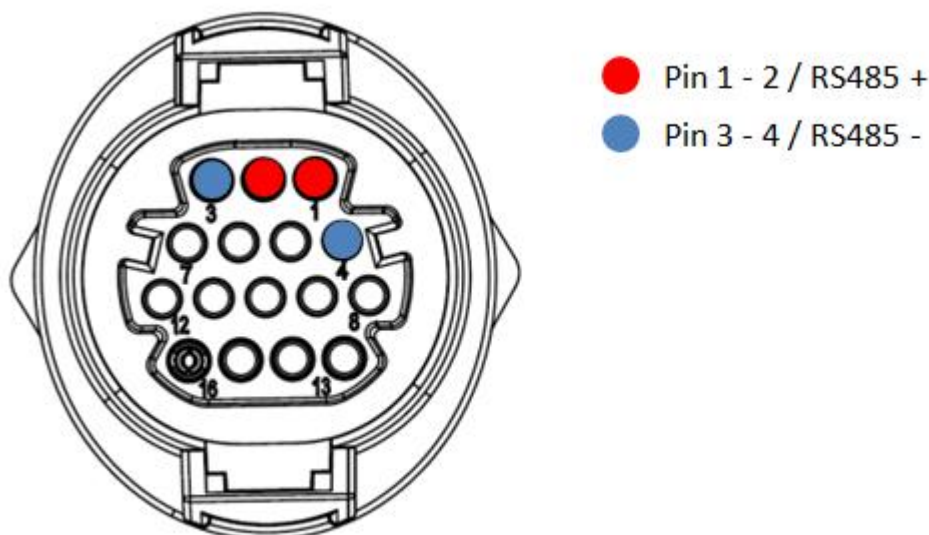

Figure 78 - Connecting the serial line via the communication connector for 3PH HYD5000-HYD20000-ZSS

- c. Position the dip switches of the last inverter of the daisy chain as shown in the figure below for activating the 120 Ohm resistor and closing the communication chain. If there are no switches, physically connect a 120 Ohm resistor to terminate the bus.

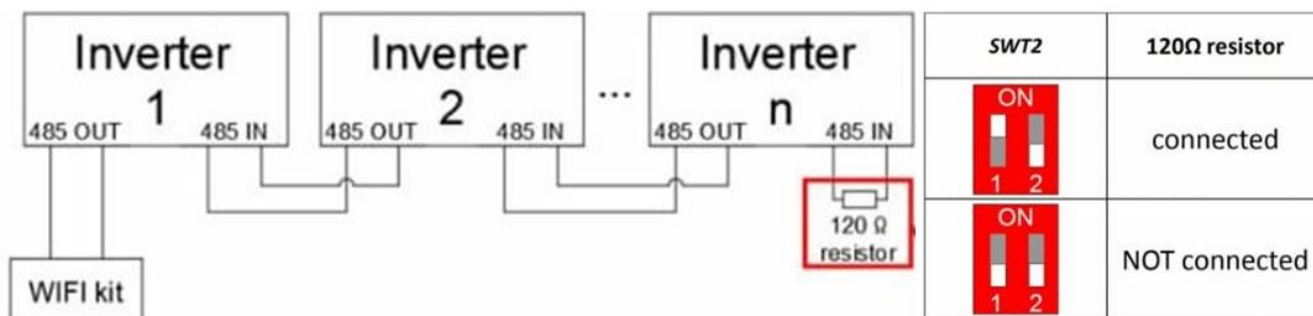

Figure 79 – Positioning of dip switches to connect the isolation resistor

- 3) Check that the RS485 icon is shown on the display of all the inverters. This indicates that the inverters are actually connected via the serial line. If this symbol does not appear, check that the connection is correct, as indicated in this guide.

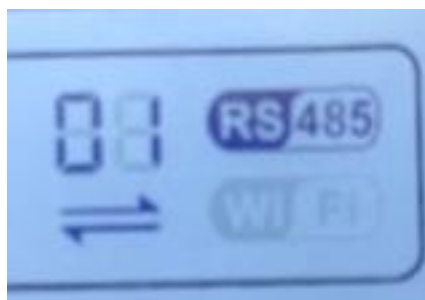

Figure 80 – RS485 symbol on the display of the inverter

- 4) Set a sequential Modbus address on each inverter connected:
- Enter the “Settings” menu.
  - Scroll to the submenu “Modbus Address.”
  - Change the digits and set an increasing address on each inverter, starting from 01 (first inverter) to the last inverter connected. The Modbus address will be shown on the display of the inverter alongside the RS485 symbol. There should be no inverters with the same Modbus address.

### 10.4.3. ZSM-DATALOG-04 AND ZSM-DATALOG-10 DEVICES

The initial status of the LEDs on the datalogger will be:

- POWER steady on
- 485 steady on
- LINK off
- STATUS steady on

### 10.4.4. WI-FI CONFIGURATION

To configure the datalogger via Wi-Fi, please refer to the chapter on monitoring systems, as the configuration is similar to that of any type of Wi-Fi adapter.

### 10.4.5. Ethernet configuration

- 1) Insert the RJ45 connector of the Ethernet cable in the ETHERNET input of the datalogger.



Figure 81 – Ethernet cable connected to the datalogger

- 2) Connect the other end of the Ethernet cable to the ETH output (or equivalent) of the modem or a suitable data transmission device.
- 3) Activate the search for Wi-Fi networks on your phone or PC in order to display all the networks visible from your device.

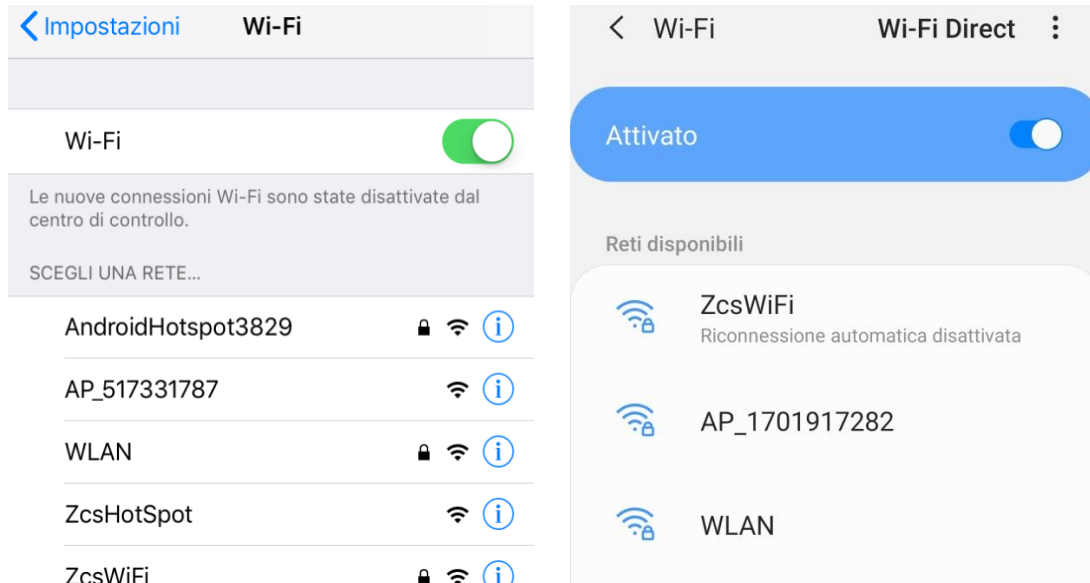

Figure 82 - Wi-Fi network search on iOS smartphone (left) and Android (right)

Note: Disconnect from any Wi-Fi networks to which you are connected by removing automatic access.



Figure 83 - Disabling automatic reconnection to a network

- 4) Connect to a Wi-Fi network generated by the datalogger (i.e. AP\_\*\*\*\*\*, where \*\*\*\*\* indicates the serial number of the datalogger shown on the label of the device), which operates as an Access Point.
- 5) Note: To ensure that the datalogger is connected to the PC or smartphone during the configuration procedure, enable automatic reconnection of the AP\_\*\*\*\*\* network.

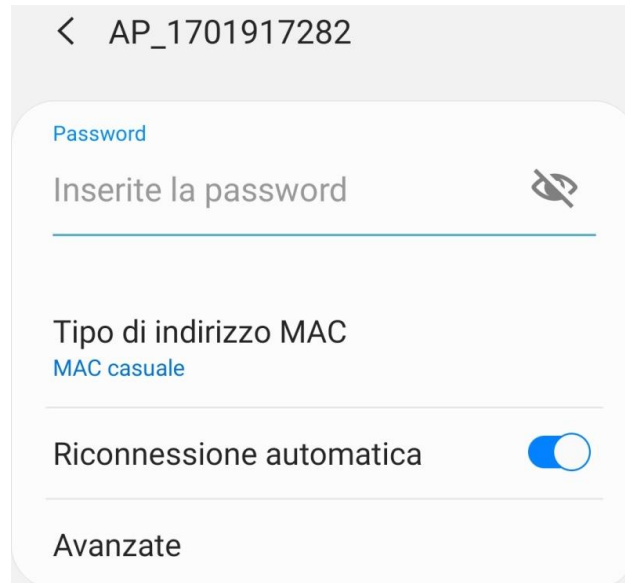

Figure 84 - Password entry prompt

Note: the Access Point is not able to provide internet access; confirm to maintain the Wi-Fi connection, even if internet is not available.

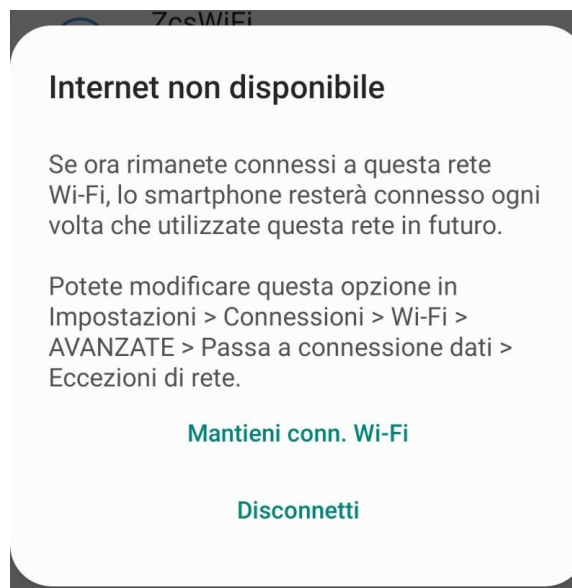

Figure 85 - Screen showing that the Internet cannot be accessed

- 6) Open a browser (Google Chrome, Safari, Firefox) and enter the IP address 10.10.100.254 in the address bar at the top of the screen.  
In the box that appears, enter "admin" as both Username and Password.



Figure 86 - Screen for logging into the web server to configure the datalogger

- 7) The status screen will open, showing the datalogger information such as serial number and firmware version.

Check that the fields relating to the Inverter Information are filled in with the information of all the inverters connected.

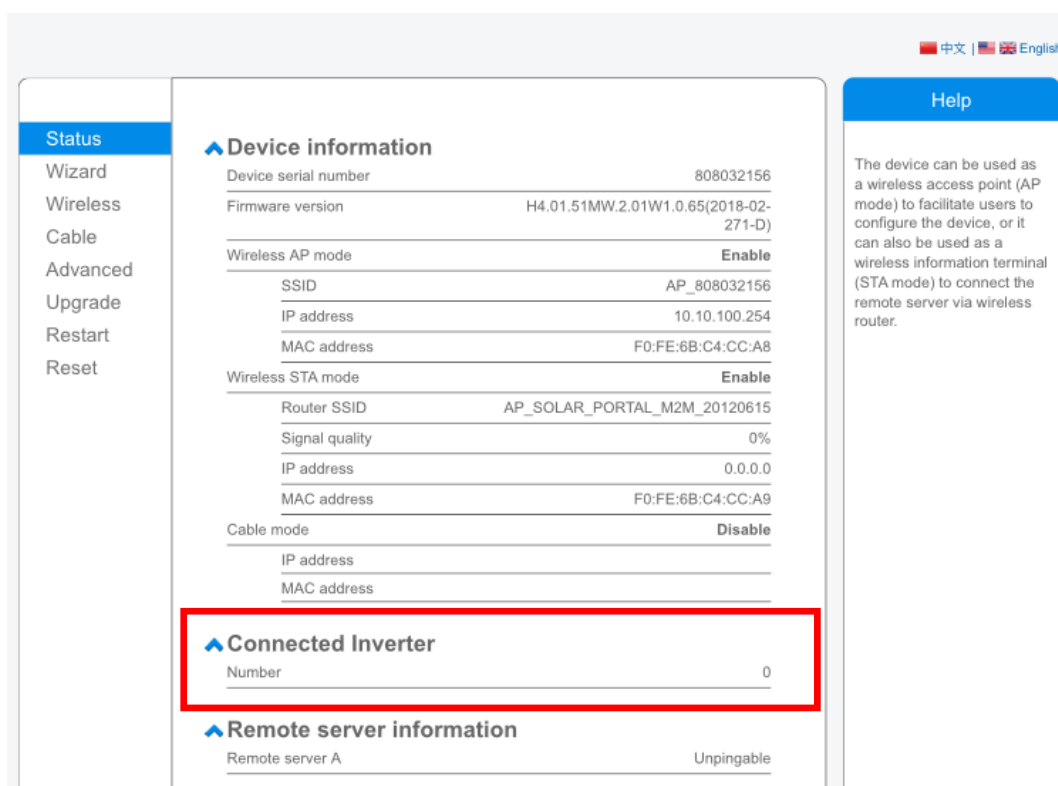

Figure 87 – Status Screen



- 8) Click on the Wizard setup button in the left-hand column.
- 9) Now click on the Start button to start the configuration wizard.

Dear user:

Thank you for choosing our device.  
Next, you can follow the setup wizard to complete the network setting step by step;  
or you can select the left menu for detailed settings.

★Note: Before setting, please make sure that your wireless or cable network is working.

Start



Figure 88 – Screen for starting (1) the Setup Wizard

- 10) Check the “Cable Connection” option and then click “Next.”

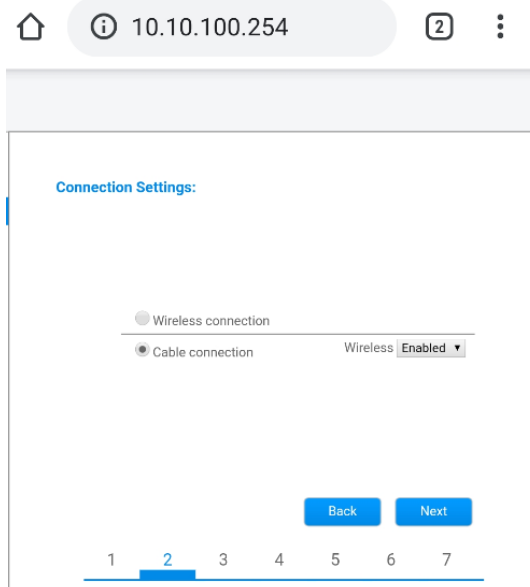

Figure 89 - Network cable connection selection screen

11) Make sure that the “Enable” option is selected to automatically obtain the IP address from your router, then click Next.

Please fill in the following information:

Obtain an IP address automatically	Enable ▾
IP address	0.0.0.0
Subnet mask	0.0.0.0
Gateway address	0.0.0.0
DNS server address	

1   2   3   4   **5**   6   7

Figure 90 - Screen for automatically obtaining the IP address (5)

12) Click on Next without making any changes.

**Enhance Security**

You can enhance your system security by choosing the following methods

Hide AP

---

Change the encryption mode for AP

---

Change the user name and password for Web server

1   2   3   4   5   **6**   7

Figure 91 - Screen for setting the security options (6)

13) Complete the configuration procedure by clicking OK, as shown in the following screen.

**Configuration completed!**

Click OK, the settings will take effect and the system will restart immediately.

If you leave this interface without clicking OK, the settings will be ineffective.

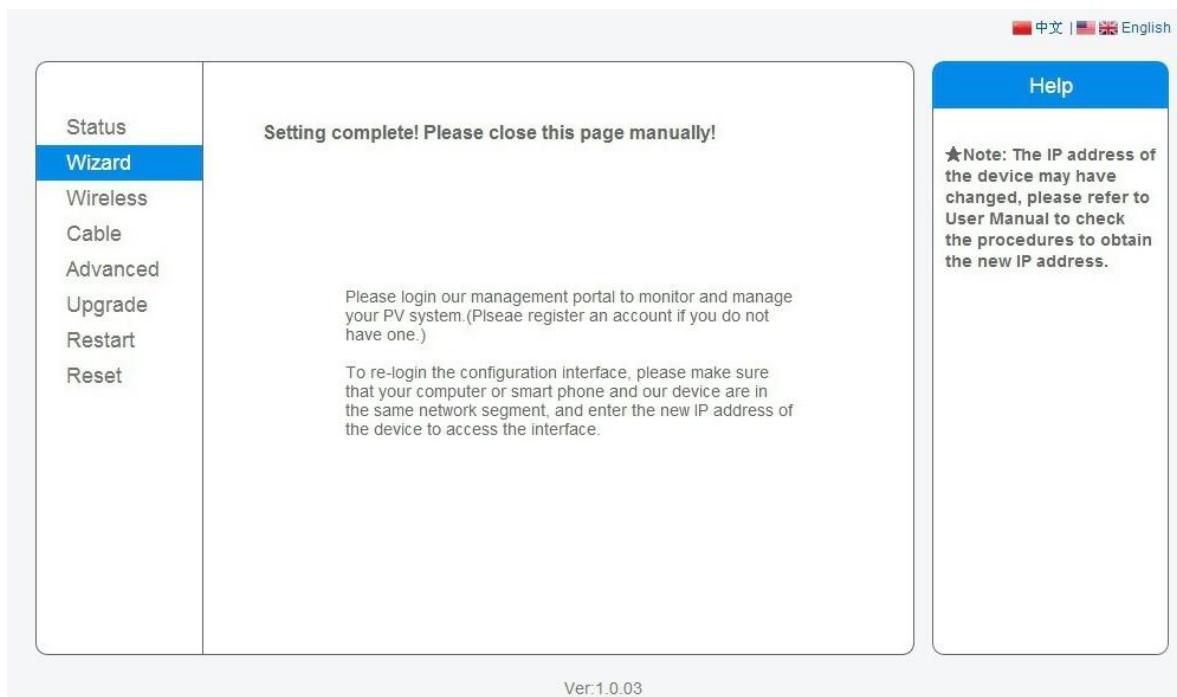

**Figure 92 – Final configuration screen (7)**

14) If the configuration procedure is successful, the following screen will appear.

If this screen does not appear, try refreshing the browser page.

The screen will prompt you to manually close the page; close the page from the background of your phone or from the close button on your PC.



**Figure 93 – Successful configuration screen**

#### 10.4.6. Checking that the datalogger has been configured correctly

Wait two minutes after completing the configuration of the device.  
First of all, check that the LINK LED on the device is on and steady.



Figure 94 – LED indicating the correct configuration of the datalogger

Enter the IP address 10.10.100.254 again, and the login credentials (“admin” for both username and password). Once logged in, the Status screen will appear, where the following information can be checked:

- Check Wireless STA mode (if the datalogger has been configured via Wi-Fi)
  - Router SSID > Router name
  - Signal Quality > other than 0%
  - IP address > other than 0.0.0.0
- Check Cable mode (if the datalogger has been configured via Ethernet cable)
  - IP address > other than 0.0.0.0
- Check Remote server information
  - Remote server A > Pingable

#### Device information

Device serial number	508263482
Firmware version	H4.01.51MW.2.01W1.0.74(2019-03-143-D)
Wireless AP mode	<b>Enable</b>
SSID	AP_508263482
IP address	10.10.100.254
MAC address	BC:54:F9:F6:B9:74
Wireless STA mode	<b>Enable</b>
Router SSID	iPhone di Giacomo
Signal quality	100%
IP address	172.20.10.10
MAC address	BC:54:F9:F6:B9:75
Cable mode	<b>Disable</b>
IP address	
MAC address	

#### Connected Inverter

Type	ZCS
Number	1
Inverter serial number	ZA1ES111G8R273 ▼
Firmware version (main)	V550
Firmware version (slave)	---
Inverter model	ZA1ES111
Rated power	1 00 W
<b>Current power</b>	<b>0 W</b>
<b>Yield today</b>	<b>0 kWh</b>
<b>Total yield</b>	<b>0 kWh</b>
Alerts	F12F14
Last updated	0 min ago

#### Remote server information

Remote server A	Pingable
-----------------	----------

Figure 95 – Main status screen and checking of correct configuration

Cable mode	<b>Enable</b>
IP address	192.168.0.177
MAC address	BC:54:F9:F6:B9:77

Figure 96 - main status screen and checking of correct configuration

If the Remote Server A item in the Status page is still “Unpingable”, the configuration was not successful, i.e. the incorrect router password was entered or the device was disconnected during connection.

It is necessary to reset the device:

- Select the Reset button in the left-hand column
- Press the OK button to confirm
- Close the web page and enter the Status page again. At this point, the configuration procedure can be repeated again.



- Status
- Wizard
- Wireless
- Cable
- Advanced
- Upgrade
- Restart
- Reset**

### Restore factory setting

**★Important:**

After restoring factory settings, all users' configuration be deleted. You can reconfigure it on <http://10.10.100.2> Account and password are both "admin".

Are you sure to reset now?

OK

Back

Figure 97 – Reset Screen

### 10.4.7. ZSM-RMS001/M200 and ZSM-RMS001/M1000 Devices

#### 10.4.7.1. Mechanical description and Datalogger interface

**Mechanical Dimensions:** 127mm x 134 x 52 mm

**Protection rating:** IP20

The usable ports are indicated below.

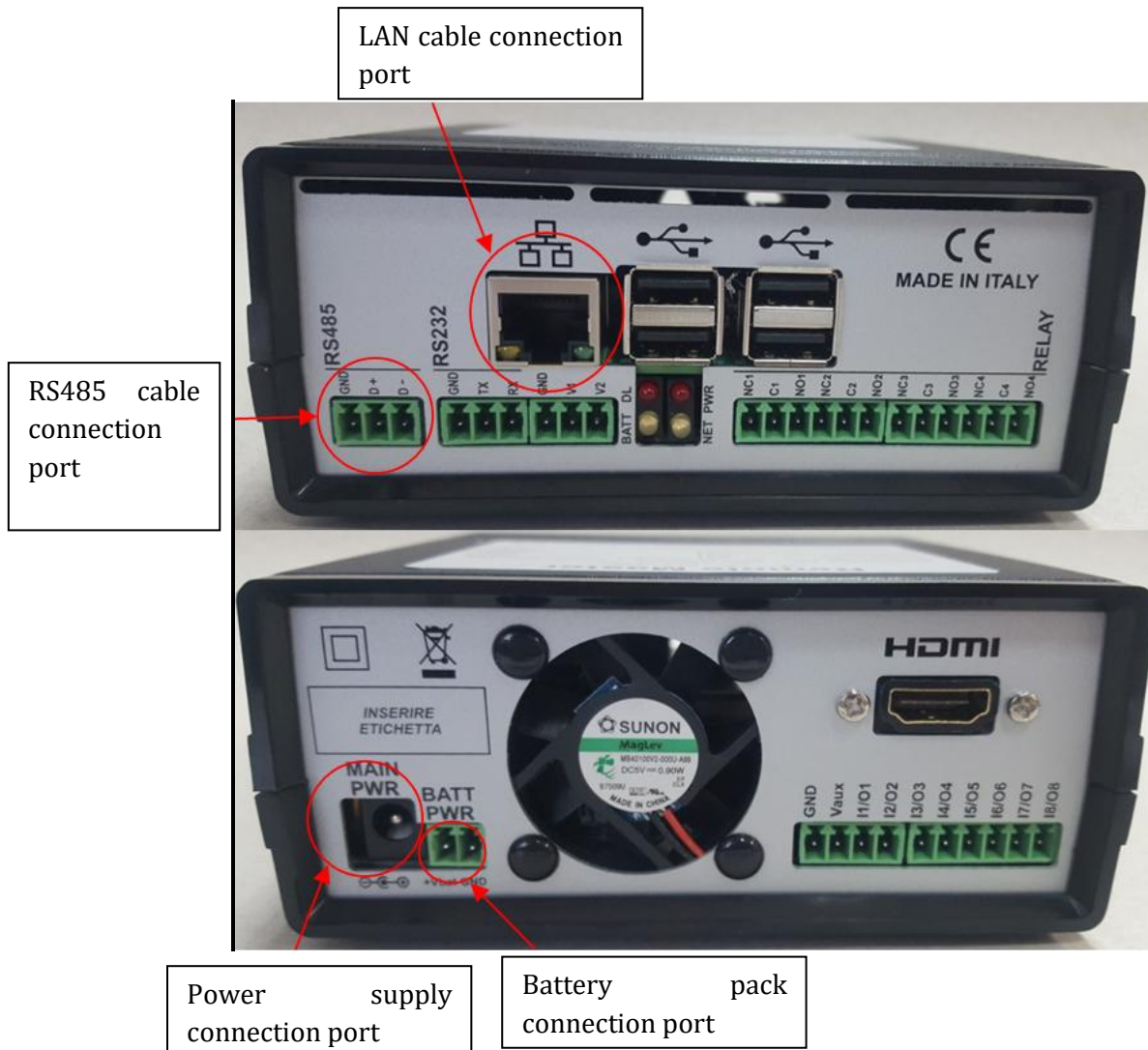

Figure 98 - Datalogger rear panel

#### 10.4.7.2. Connecting the Datalogger to the inverters

A serial communication via RS485 cable is provided for connecting to the inverters.

The GND cable does not need to be connected to the inverters. Follow the connections as shown in the table below.

Datalogger SIDE	BUS Signal	SENSOR SIDE (ZSM-IRR-TEMP-LM2)	Inverter SIDE
<b>D+</b> terminal	+	RS485- <b>IB</b> terminal	<b>+Tx</b> terminal
<b>D-</b> terminal	-	RS485- <b>IA</b> terminal	<b>-Tx</b> terminal

**Table 3: Connecting the Datalogger to the inverters**

### 10.4.7.3. Internet connection via Ethernet cable

In order to display the data measured and processed by the Datalogger in the portal, it is necessary to connect to the internet via LAN cable and open the following router ports:

- VPN ports: 22 and 1194
- HTTP ports: 80
- DB ports: 3050
- FTP ports: 20 and 21

The local network of the device is configured for DHCP, and it is not necessary to activate any communication port on the router. If you want to set a fixed network address, this must be provided at the time of ordering together with the gateway address.

### 10.4.7.4. Connecting the power supply and battery pack to the Datalogger

Once the RS485 Half Duplex cable has been connected, power the Datalogger by connecting the power supply unit (supplied with the datalogger) to the MAIN PWR input (12V DC - 1A).

In order to prevent possible voltage drops and/or power failures, it is recommended to also connect the battery pack, which is supplied with the datalogger. The battery pack should be connected to the +V<sub>bat</sub> and GND inputs of the BATT PWR connector, positive and negative respectively (i.e. red to the +V<sub>bat</sub> input and black to the GND input).

The battery pack (ZSM-UPS-001) can be purchased separately.



### 10.4.7.5. Connecting the LM2-485 PRO cell irradiance and temperature sensor to the datalogger

For proper installation, make sure to connect the sensor signal cable and the power cable.



In particular, the sensor of the signal cables must be connected in a daisy chain configuration to the remaining devices on the RS485 bus, as shown in the table below.

Datalogger SIDE	BUS Signal	SENSOR SIDE (ZSM-IRR-TEMP-LM2)	Inverter SIDE
<b>D+</b> terminal	+	RS485+ <b>IB</b> terminal	+ <b>Tx</b> terminal
<b>D-</b> terminal	-	RS485- <b>IA</b> terminal	- <b>Tx</b> terminal

To supply power to the sensor, the datalogger can be directly connected to the mains power, as shown in the table below, or connected to an external +12Vdc power supply.

Datalogger SIDE	SENSOR SIDE
<b>V1</b> terminal	<b>RED +12V</b>

(12Vdc output voltage)	Terminal
<b>GND</b> terminal (GND/RTN)	<b>BLACK 0V</b> Terminal
<b>V2</b> terminal (12Vdc driveable voltage)	

**Table 4: Electrical connection of the sensor to the datalogger (power supply)**

A stable communication in terms of signal and power supply, up to 200m, is guaranteed by using the RS485 cable, type Te.Co. 15166 (2x2x0,22+1x0,22)st/pu.

For longer distances, a connection to the signal side of the datalogger is recommended, and a connection to the +12V power supply via an external power supply unit.

### 10.4.8. Configuring the Datalogger

Connect to the website [dlconfig.it](http://dlconfig.it) and login by entering the temporary credentials: Username = admin and Password = admin.

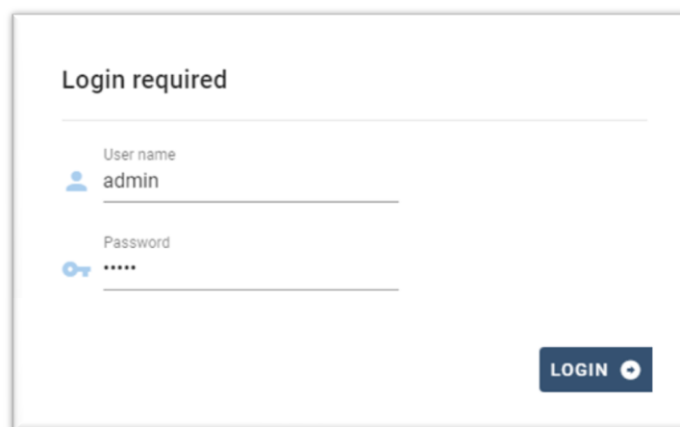

In the screen that opens, enter the serial number(S/N) of the datalogger to be configured and click "SEARCH".

### Datalogger search

Please, enter a datalogger serial number

---

Serial number  
RMS00000005

---

SEARCH

In the configuration page, you can search for any devices connected to the datalogger (inverter, meter or sensors) by clicking the + button, as shown in the figure.

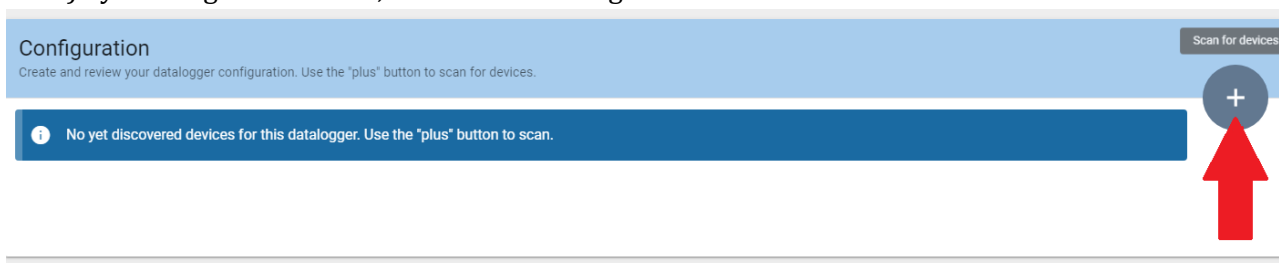

A window will open where you can search for each type of device connected to the Datalogger, after indicating the range of addresses associated with the relative devices.

### Scan

Command the datalogger to perform a discovery. Find and confirm new and old devices.

Device Type

- Sensor
- Meter
- Inverter

Vendor

Protocol

CANCEL   NEXT

If a meter is one of the devices connected to the Datalogger, select the type of Meter/Datalogger communication interface and the relative communication protocol.

**Scan**  
Command the datalogger to perform a discovery. Find and confirm new and old devices.

Device Type: Meter  
Vendor: Algodue

Interface: RS-485  
Protocol: \_\_\_\_\_

CANCEL NEXT

**Scan**  
Command the datalogger to perform a discovery. Find and confirm new and old devices.

Device Type: Meter  
Vendor: Algodue

Interface: RS-485  
Protocol: ASCII  
RTU

CANCEL NEXT

Once this operation has been completed, update the new configuration by clicking “Confirm,” which will allow you to register the devices associated with the datalogger.

**Confirm changes**

State:

Confirming new: 1

Total now: 1

**CONFIRM**

From this moment, the datalogger is correctly configured (all devices must be in the “saved” status) and therefore a new installation can be created on the ZCS Azzurro portal for associating the datalogger and the devices connected to it.

**Configuration**  
Create and review your datalogger configuration. Use the “plus” button to scan for devices.

Scan for devices 

Device Type	Direction	Vendor	Interface	Protocol	Serial number	Slave Id	Status	
Inverter		ZCS	RS-485	RTU	ZM1ES030JC4258	1	Saved	:

### 10.4.8.1. Configuring the Datalogger on the ZCS Azzurro portal

Access the ZCS Azzurro portal (<https://www.zcsazzurroportal.com>). For new users, click “Sign up now” to register on the portal by entering your email, username and password. After logging into the portal, click “Configuration Panel”, and then select the option “Create field with Datalogger.” The “Create New Field” operation will be possible only if the user’s privileges allow acquiring new fields (at the time of registration the limit will be equal to 1, an upgrade is required to increase the limit).



Enter the serial number (S/N) of the datalogger and click “Check RMS”. If the datalogger has been configured correctly, a screen will open where you can enter the required information relating to the field to be installed.

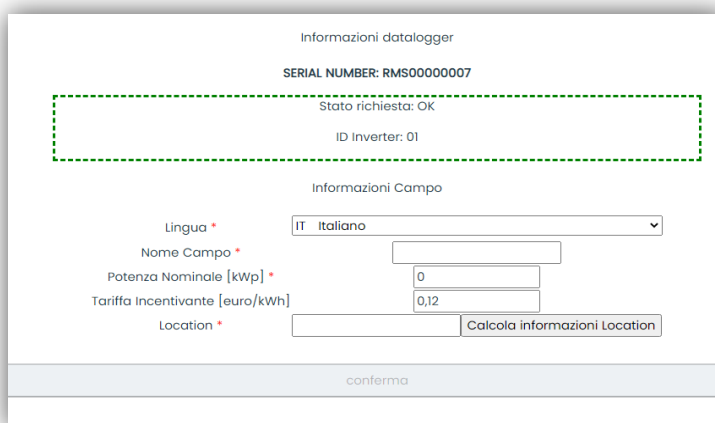

Once the “location” of the field has been entered, click “Calculate Location Information” to allow the system to obtain the latitude, longitude and time zone of the installation. Click “Confirm” to complete the configuration of the field. You only need to wait a few minutes to view the data flow on the ZCS Azzurro portal.

**ATTENTION: The location data is essential for the correct operation of the datalogger in the ZCS system. It is important to define it very carefully.**

## 10.4.8.2. Network configuration

At the time of purchase, the Datalogger is configured in DHCP, i.e. dynamic configuration. However, if you want to set up a static configuration for your Datalogger, you can access the internet page via the link RMSxxxxxxxx: 8888, as shown in the figure (e.g. RMS00000007).

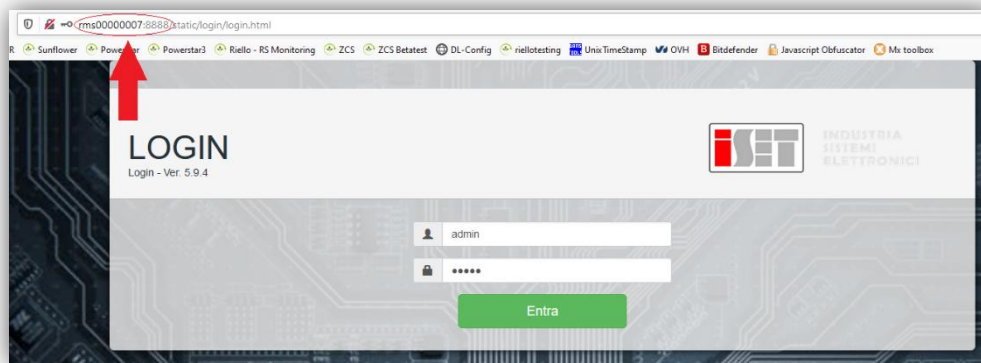

By entering the credentials: username = admin and password = admin, you can change the configuration from dynamic to static by selecting the network window (see [blue arrow](#)) and then the “STATIC” option (see [green arrow](#)).

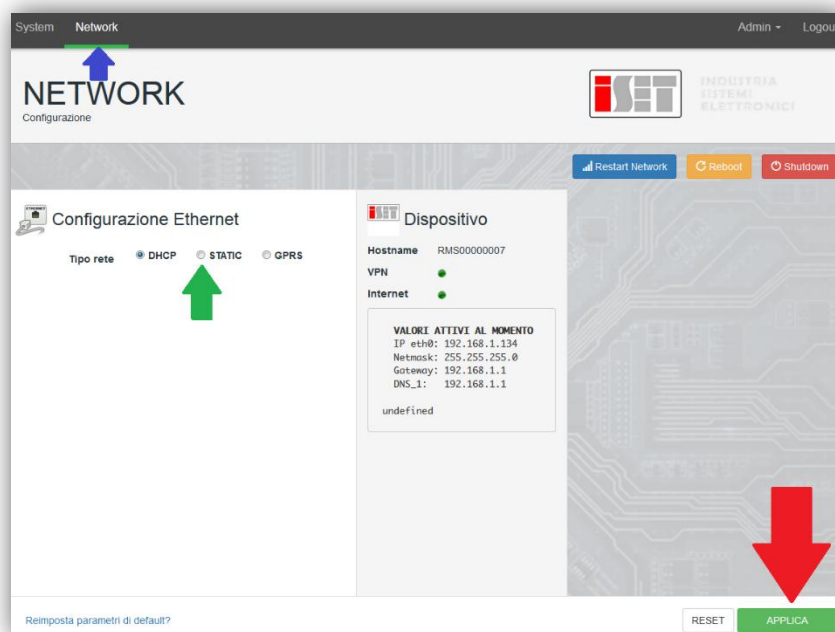

To complete the operation, click “Apply” (see [red arrow](#)).

### 10.4.9. Local monitoring

The datalogger makes it possible to obtain an additional monitoring system (**local monitoring**), which can be used locally on a web page (therefore, also without an internet connection) and accessed from any device present in the same local network as the datalogger.

### 10.4.9.1. Requirements for installation of local monitoring

In order to install the local monitoring system on the datalogger, the customer must ensure that:

- The datalogger is connected to the local network and to the internet (the internet connection is only required during installation and configuration of the local monitoring system).
- A static address (to be provided by the customer) with gateway and subnet mask is available for viewing the page locally.

### 10.4.9.2. Features of local monitoring

After installation and configuration, local monitoring makes it possible to monitor the fundamental parameters of the photovoltaic system, even without an internet connection, from any device connected to the same local network.

In particular, it is possible to monitor the power and energy of the inverters and the storage systems over the last 7 days. It is also possible to view alarms, and other information such as temperature, peak daily power, CO<sub>2</sub> gains and savings.

Below is an example of a local monitoring page.

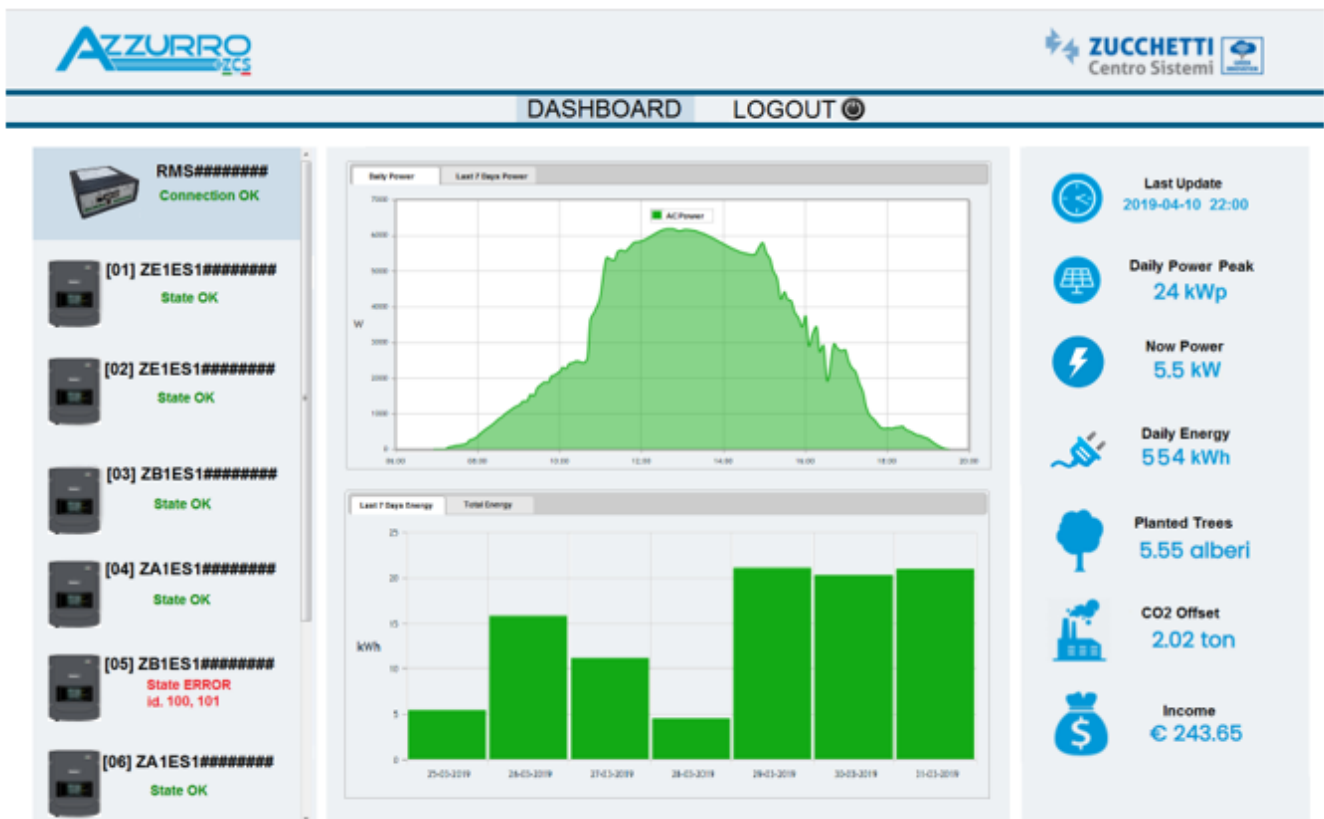

Figure 99 - Example of local monitoring page

## 11. Warranty terms and conditions

To view the “Warranty Terms and Conditions” offered by ZCS Azzurro, please refer to the documentation inside the product box and on the website [www.zcsazzurro.com](http://www.zcsazzurro.com).





---

THE INVERTER THAT LOOKS AT THE FUTURE

**[zcsazzurro.com](http://zcsazzurro.com)**



Zucchetti Centro Sistemi S.p.A.  
Green Innovation Division  
Palazzo dell'Innovazione - Via Lungarno, 167  
52028 Terranuova Bracciolini - Arezzo, Italy  
[zcscompany.com](http://zcscompany.com)

